

# JOHN BAYLOR

TEST • PREP



## ACT PRACTICE TEST #1

*Score Higher*

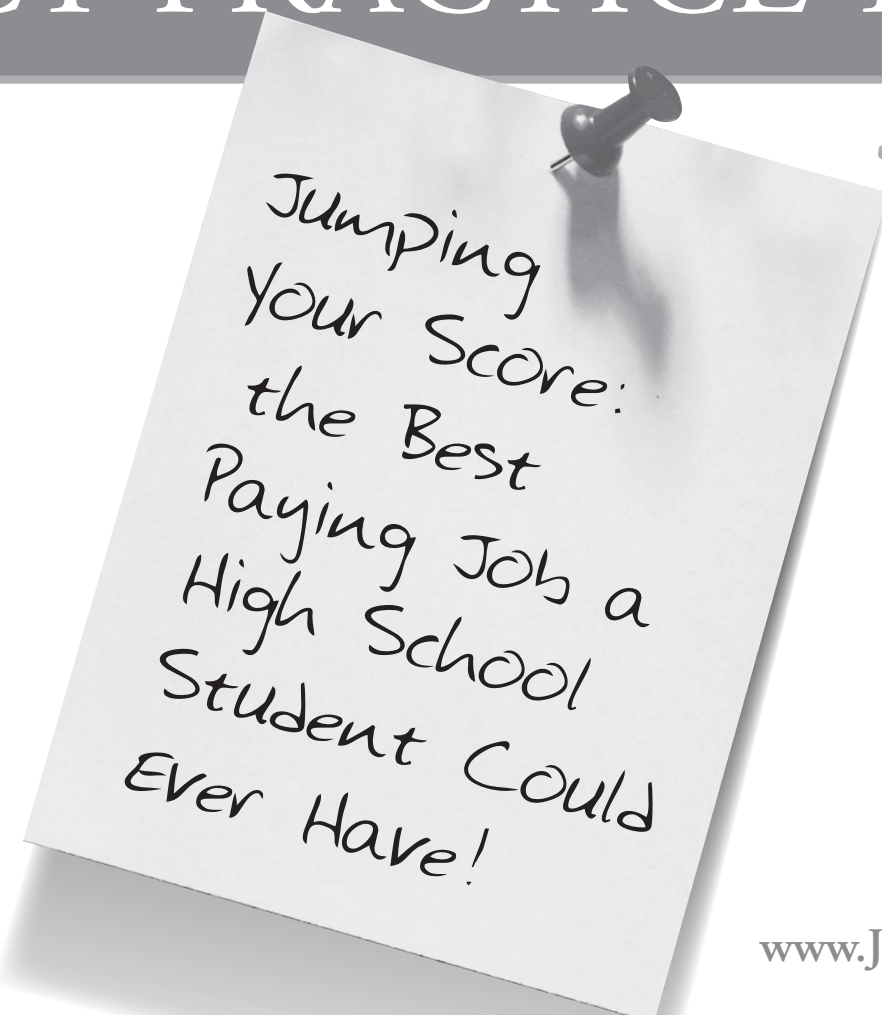

Jumping  
Your Score:  
the Best  
Paying Job a  
High School  
Student Could  
Ever Have!

[www.JohnBaylorTestPrep.com](http://www.JohnBaylorTestPrep.com)

402-475-PREP

PO Box 30792

Lincoln, NE 68503

Don't settle. Get Into the Best  
College at the Lowest Cost!

Become a JBTP Friend on Facebook. 

Follow John on Twitter @JBTestPrep.com 

Download Free Templates & Forms at Speedy Template <http://www.SpeedyTemplate.com/>

©2011-2012 JohnBaylorTestPrep.com

ACT® is the registered trademark of ACT, Inc. John Baylor Test  
Prep is not approved or endorsed by ACT, Inc.

**ENGLISH TEST**

*45 Minutes—75 Questions*

**DIRECTIONS:** In the five passages that follow, certain words and phrases are underlined and numbered. In the right-hand column, you will find alternatives for the underlined part. In most cases, you are to choose the one that best expresses the idea, makes the statement appropriate for standard written English, or is worded most consistently with the style and tone of the passage as a whole. If you think the original version is best, choose "NO CHANGE." In some cases, you will find in the right-hand column a question about the underlined part. You are to choose the best answer to the question.

You will also find questions about a section of the passage, or about the passage as a whole. These questions do not refer to an underlined portion of the passage, but rather are identified by a number or numbers in a box.

For each question, choose the alternative you consider best and fill in the corresponding oval on your answer document. Read each passage through once before you begin to answer the questions that accompany it. For many of the questions, you must read several sentences beyond the question to determine the answer. Be sure that you have read far enough ahead each time you choose an alternative.

**PASSAGE I**

**Swimming**

In 1972, a fifteen-year old American girl named Lynne Cox swam the English Channel, a waterway between England and France that spans 19 nautical miles at its narrowest point. Her time, nine<sup>1</sup> hours and 36 minutes—set a world record, and<sup>2</sup> established her<sup>2</sup> reputation in the history of long-distance swimming. More than thirty years later, at the age of forty-eight, Cox continues to set records and recently became the first human to tread the freezing waters of Antarctica. Swimming in frigid waters is nearly impossible, requiring powerful strokes that makes it<sup>3</sup> unthinkable to all but the highly trained athlete.

Swimming since an early age, Cox has achieved goals<sup>4</sup> once deemed impossible<sup>4</sup>. In the world of swimming, the English Channel is the Mount Everest: the challenge of a lifetime, though not for Lynne Cox. Her record was broken the subsequent year<sup>5</sup>, but instead of relinquishing her title, Cox returned to establish a new record, at the age of sixteen. Since then, as she has sought new aquatic challenges, her following of admiring fans have<sup>6</sup> only increased.

1. A. NO CHANGE  
B. time: nine  
C. time—nine  
D. time; nine
2. F. NO CHANGE  
G. record, establishing her  
H. record; established her  
J. record; establishing her
3. A. NO CHANGE  
B. makes them  
C. make them  
D. make it
4. F. NO CHANGE  
G. nearly impossible goals have been achieved by Cox.  
H. achieving goals once deemed impossible has become common for Cox.  
J. achieving goals once deemed impossible is what Cox has become known for.
5. Which of the following answers would be a suitable substitute to retain the same meaning?  
A. preceding year  
B. succeeding year  
C. prevailing year  
D. previous year
6. F. NO CHANGE  
G. has  
H. had  
J. will have been

She has swam<sup>7</sup> the Gulf of Aqaba, the Nile, and the Cook Strait. However, unprecedented accomplishments of strength have<sup>8</sup> not satisfied fully. Her chosen challenges have become less physical and more political. During 1987, in the midst of the Cold War, Cox swam the Bering Strait between Alaska and the USSR. Her accomplishment was a symbol of hope for two hostile countries. 9

Even though such efforts were physically and politically significant, her experience in the waters of Antarctica is the most astounding. No human had ever attempted a swim adjacent to the icy continent, but, of course Cox<sup>10</sup> has always been unique. She trained for several years, to<sup>11</sup> prepare her body for temperatures that would kill a normal person

within eight minutes<sup>12</sup>. In 2002, she swam over a mile along the coast of Antarctica, wearing only a swimsuit.

Scientists have studied Cox to discover how she can tolerate such cold temperatures. She has endured frosty temperatures since childhood, conditioning her body to withstand the cold. Still, one must also account for<sup>13</sup> her heart, which has driven her to achieve the impossible. From a young girl to an adult, Lynne Cox has tamed the oceans'<sup>14</sup> cold fury. No man or woman has been more influential at long-distance swimming than her<sup>15</sup>.

7. A. NO CHANGE  
B. swim  
C. swum  
D. swimming
8. F. NO CHANGE  
G. has  
H. would have  
J. will have
9. At this point the author is considering adding the following true statement:
- Such hope proved prophetic with the fall of communism and improved relations between Russia and the U. S.
- Should the writer make this addition here?
- A. Yes, because bringing increased freedom to Russians was a goal of hers.  
B. Yes, because it clarifies why she swam between these two countries.  
C. Yes, because it adds more relevance to her swim.  
D. No, because this information is redundant.
10. F. NO CHANGE  
G. but of course Cox  
H. but of course, Cox  
J. but, of course, Cox
11. A. NO CHANGE  
B. years — to  
C. years to  
D. years: to
12. The author is considering deleting the underlined words. If so, the sentence would primarily lose:  
F. unnecessary detail  
G. helpful biographical background  
H. vague specifics  
J. helpful details that bolster the facts within the sentence
13. A. NO CHANGE  
B. with  
C. to  
D. from
14. F. NO CHANGE  
G. the oceans  
H. the ocean's  
J. the waters
15. A. NO CHANGE  
B. she  
C. her ability  
D. herself

## PASSAGE II

## The Greatness of da Vinci

Many people are familiar with Leonardo da Vinci's artwork, a collection which includes such famous works as <sup>16</sup>*The Last Supper* and the *Mona Lisa*. In fact the *Mona Lisa* is <sup>17</sup>possibly the most recognized painting in the world. However, da Vinci was not only an artist, but a scientist and inventor. <sup>18</sup>His endeavors in other fields of knowledge enhanced his skill as an artist.

Da Vinci was born in fifteenth century Italy and his artistic <sup>19</sup>talent was discovered before he was a teenager. His father placed him as an apprentice to an influential painter Andrea del <sup>20</sup>*Verrochio*, who lived and worked in Florence. Del Verrochio had neither the understanding then of da Vinci's budding greatness nor was he aware of da Vinci's future fame. <sup>21</sup>

As da Vinci learned to paint, he became intrigued by the scientific principles that provide the foundation for art. For instance, he spent time studying *perspective*. "Perspective is nothing more than viewing a scene behind a flat, transparent piece of glass on whose surface all the objects located behind the glass have been drawn," he wrote. He studied such principles with a scientific precision in his sketches and paintings. 22

He eventually opened his own studio in Milan, where he continued painting portraits. He later was hired to be a theater designer, an architect, and worked as a sculptor. <sup>23</sup>

16. Which answer choice is NOT grammatically correct?  
 F. NO CHANGE  
 G. artwork; a  
 H. artwork-- a  
 J. artwork: a
17. A. NO CHANGE  
 B. In fact,  
 C. Ironically,  
 D. Nevertheless,
18. F. NO CHANGE  
 G. whereas  
 H. nor  
 J. but also
19. A. NO CHANGE  
 B. Italy; and his  
 C. Italy; his  
 D. Italy and
20. F. NO CHANGE  
 G. painter, Andrea del Verrochio  
 H. painter; Andrea del Verrochio  
 J. , painter Andrea, del Verrochio
21. A. NO CHANGE  
 B. nor was he aware of da Vinci's fame.  
 C. nor the awareness of da Vinci's future fame.  
 D. nor was the awareness of da Vinci's future fame known by him.
22. Which of the following best summarizes the preceding paragraph?  
 F. Da Vinci studied perspective as well as sketched and painted.  
 G. Da Vinci cared not only about his finished product, but also at least as much about art's foundational principles.  
 H. Even da Vinci's teenage art became influential.  
 J. Da Vinci's work was precise.
23. A. NO CHANGE  
 B. did some sculpting  
 C. sculpted occasionally  
 D. a sculptor



Obsessed with philosophical, architectural, scientific, and artistic ideas, finding the answers to questions was his greatest<sup>24</sup> love<sup>24</sup>. His passion was not only the end product, but also the

process of discovery; of the two, it was the process that fascinated him more<sup>25</sup>.

Da Vinci also loved to sketch inventions, though he rarely built the machines. Regardless of what detractors at<sup>26</sup> the time said<sup>26</sup>, his drafts were far ahead of their time. In an era of horse and carriage, he was designing tanks, solar powered machines, calculators, and flying contraptions. Da Vinci had a modern mind in the midst of the pre-modern Renaissance.

So where is da Vinci's place in history at?<sup>27</sup> If da Vinci had concentrated solely on painting, he probably would have created many more masterpieces. Because his great works however<sup>28</sup>, were inspired by his scientific and philosophical endeavors, it is also probable that, without this additional knowledge, he would not have been one of the world's celebrated painters. His collection of influential paintings, though not as numerous as we might wish, remain<sup>29</sup> an inspiration to a grateful world.

24. F. NO CHANGE  
G. the answers to questions were his greatest love.  
H. the questions meant an answer for him to find.  
J. he loved to find the answers to questions.

25. A. NO CHANGE  
B. as much  
C. most  
D. least

26. Which of the following is NOT correct?  
F. NO CHANGE  
G. Irregardless of what detractors at the time said  
H. Despite what supporters at the time said  
J. In spite of what advocates at the time said

27. A. NO CHANGE  
B. So where is da Vinci's place in history near?  
C. So where is da Vinci's place in history?  
D. So where is da Vinci's place in history by?

28. F. NO CHANGE  
G. , however,  
H. , however  
J. however

29. A. NO CHANGE  
B. remains  
C. have remained  
D. will have remained

Question 30 asks about the preceding passage as a whole.

30. If the author had intended to write an essay questioning whether da Vinci deserved his celebrated, prodigious reputation, would this essay accomplish that purpose?  
F. Yes, because the author suggests that da Vinci was distracted by unrelated pursuits.  
G. Yes, because the author asks about da Vinci's place in history in the final paragraph.  
H. No, because the author reinforces da Vinci's reputation by explaining the training and ultimately the foundation for his artistic greatness.  
J. No, because the author expresses his belief that da Vinci may not be one of history's greatest painters.

## PASSAGE III

## Chess

Epic man-versus-machine battles, featuring sovereign computers capable of cunning and treachery—have taken almost Manichean form in the pages of science fiction. But there is one finite battleground where computers have performed remarkably well against their creators: the chessboard.

[1] In 1769, Wolfgang von Kempelen presented the world with an autonomous chess machine he called “The Turk.” [2] Resembling a Maplewood cabinet, it had a turbaned mannequin sitting behind it. [3] The idea of a chess-playing “computer” dates to at least the eighteenth century. [4] A clever series of illusions revealed a phony clock-like machine behind the cabinet doors, but those illusions enabled a human to hide inside and operate the mannequin. [32]

The secrets of The Turk had been eventually revealed in several exposes (one by Edgar Allen Poe), but for over fifty years it traveled the world, checkmating such historical figures, for example, as Napoleon Bonaparte and Benjamin Franklin.

More than two centuries later, chess computing has come a long way from functionless gears and life-size puppets. IBM’s Deep Blue is no doubt the most famous computer chess program yet devised. At the time that it made it’s greatest conquest, challenging world champion Gary Kasparov in 1996, Deep Blue was far and away the strongest chess program ever. Deep Blue has been then capable of evaluating a remarkable 200,000,000 moves each second. Kasparov won the match, but a year later an updated version of Deep Blue

31. A. NO CHANGE  
B. treachery, have  
C. treachery have  
D. treachery; have
32. Which of the following sequences of sentences makes this paragraph most logical?  
F. NO CHANGE  
G. 1, 3, 4, 2  
H. 3, 1, 2, 4  
J. 3, 2, 4, 1
33. A. NO CHANGE  
B. was  
C. are  
D. were
34. F. NO CHANGE  
G. for example,  
H. , for example  
J. OMIT the underlined section
35. Which choice below does NOT agree with the sentiment of the underlined word?  
A. undeniably  
B. doubtless  
C. doubtfully  
D. undoubtedly
36. F. NO CHANGE  
G. its’  
H. its  
J. the
37. A. NO CHANGE  
B. is  
C. was  
D. will be
38. F. NO CHANGE



won a rematch. High school students today would benefit greatly if they studied and played chess: few activities sharpen the mind more effectively.

Since Deep Blue's defeat of Kasparov, a number of other computers have reached and even surpassed the level of play

and analysis reached by Deep Blue. This threshold represented in many minds, the first time a computer had surpassed a human in an activity requiring great intuition and creativity. Still, computer chess programs have taught us little about artificial intelligence or the ability of computers to "learn."

We have neither a reason to fear them nor limit them because even the best chess programs have a very small amount of actual chess knowledge. All evidence points to a tremendous amount of brute calculative force masquerading as creativity and intuition. The best chess programs in the world represent only what humans have accepted for decades: computer superiority in mathematical processing. The human monopoly on creative strategy, for now, endures. 44

- G. High school students today would benefit greatly if they studied and played chess: few activities sharpen the mind more effectively than chess.
- H. High schools should mandate that students study and play chess: few activities sharpen the mind more effectively.
- J. OMIT the underlined sentence.

39. A. NO CHANGE  
B. will have  
C. has  
D. had

40. F. NO CHANGE  
G. represented, in  
H. represented-- in  
J. represented: in

41. A. NO CHANGE  
B. Indeed,  
C. While,  
D. For example,

42. F. NO CHANGE  
G. to limit them  
H. a reason for limiting them  
J. a reason to limit them

43. A. NO CHANGE  
B. decades; computer  
C. decades computer  
D. decades computer,

44. The final sentence, as written, is presented as:  
F. a fact  
G. a hope  
H. an opinion  
J. a falsehood

Question 45 asks about the preceding passage as a whole.

45. If the author intended to write a thorough history of human-versus-machine competition, would this essay accomplish that goal?
- A. Yes, because this essay provides a chronological history of machines competing with humans.
  - B. No, because this essay covers a history of computers competing with humans at chess only.
  - C. No, because this essay is biased too much in favor of humans to be objective.
  - D. No, because this essay does not include science fiction battles between humans and machines.

## PASSAGE IV

## A Best Friend

Hearing my aunts'<sup>46</sup> voice makes me smile. "All right, your<sup>47</sup> here," she often announces upon my arrival. But one issue causes friction between us. My Aunt Flora despises dogs and tried<sup>48</sup> to dissuade me when she heard that I was adopting a puppy—a<sup>49</sup> basset hound named Ruppert. "Dogs are man's best friend," I explained.

"Dogs are man's worst enemy," she replied tartly. I don't usually act against the wishes of my Aunt.

After giving it much thought, Ruppert became our<sup>50</sup> housemate. Ruppie as<sup>51</sup> we liked to call him, filled our home with excitement.

Indefatigable,<sup>52</sup> he regularly escaped from our fenced yard. Each time, he would bound<sup>53</sup> out as fast as he could, while we sprinted after him. Unfortunately, Ruppert thought that the chase was a game. He didn't realize he was the only one having fun.

When Aunt Flora called, I was forced to admit that we had discipline problems with Ruppert. "As I've told you, dogs are trouble;<sup>54</sup> they smell bad and eat too much." Still I

46. **F.** NO CHANGE  
**G.** aunts  
**H.** aunt's  
**J.** aun'ts
47. **A.** NO CHANGE  
**B.** you're  
**C.** it's great that your  
**D.** its great that you're
48. **F.** NO CHANGE  
**G.** dogs, and tried  
**H.** dogs; tried  
**J.** dogs; and tried
49. Which of the following alternatives is NOT acceptable?  
**A.** NO CHANGE  
**B.** puppy: a  
**C.** puppy, a  
**D.** puppy; a
50. **F.** NO CHANGE  
**G.** my wife and I adopted Ruppert.  
**H.** the house became Ruppert's home.  
**J.** the neighborhood had another dog: Ruppert.
51. **A.** NO CHANGE  
**B.** Ruppie-- as  
**C.** Ruppie, as  
**D.** Ruppie: as
52. **F.** NO CHANGE  
**G.** Indefatigable he  
**H.** Indefatigable: he  
**J.** Indefatigable he,
53. Which of the following answers is NOT correct?  
**A.** NO CHANGE  
**B.** bounded  
**C.** ran  
**D.** bounds
54. Which of the following answers is NOT correct?  
**F.** NO CHANGE  
**G.** trouble, they  
**H.** trouble: they  
**J.** trouble-- they



knew that none of those things are true about Ruppie.  
55

To prove this, I became very serious about observing him, training him, and kept records about any progress. Puppy training requires dedication but pays off when you end up with a happy, disciplined dog. Statistics may show that the percentage of dogs exhibiting disruptive behavior have been  
56 57

increasing, but the solution to an undisciplined dog is a disciplined owner. [58]

Unbelievably, after a couple months, Ruppert became well-behaved. The hard work generated the intended affect.  
59 When Aunt Flora visited, she was amazed to see a dog that would sit, stay, and roll over on command. “He’s not as bad as he could be, I suppose,” she relented.

This small admission pleased me, but not as much as I had expected. I was happier to have a good dog than to win an argument. [60]

55. A. NO CHANGE  
B. was  
C. have been  
D. were
56. F. NO CHANGE  
G. did keep  
H. was keeping  
J. keeping
57. A. NO CHANGE  
B. has been  
C. were  
D. are
58. The author is considering eliminating the paragraph’s final sentence that begins with ‘Statistics may show.’ Should this sentence be eliminated?  
F. YES, because the sentence provides statistics that the essay does not later substantiate.  
G. YES, because the sentence diverges unnecessarily from the story narrative.  
H. NO, because the sentence’s sentiment reinforces the theme of the paragraph.  
J. NO, because Ruppert is a dog few owners could tame.
59. Which of the following answers is NOT correct?  
A. NO CHANGE  
B. effect  
C. result  
D. outcome
60. What is the reason for Aunt Flora’s animosity towards dogs?  
F. a dog bite dating back to her youth  
G. a strong dislike for Scooby Doo and other TV dogs  
H. an allergic condition  
J. the essay never explains.

## PASSAGE V

## Does Birth Order Make a Difference?

If you have ever played Monopoly or have experienced the buying or selling of a home, you know the golden words of real estate: *location, location, location*.

A home's value can fluctuate dramatically, depending primarily on where it is positioned. The same idea can be applied to a family. Just as the position of a house can add or detract from its value, a child's birth order will affect personality. Birth order does not determine character, but it can contribute to character traits.

For instance, the first-born child is in a position of leadership. Many parents who expect their first-born to 'set an

example' for the younger siblings; an often overwhelming responsibility. According to psychologists, a percentage of

first-borns resent such pressure, though most are motivated to

meet or exceed their parents' expectations. Thus, first-borns build an internal drive to live up to the demands of others, whether such demands are real or imagined.

Because the older sibling tends to lead and oversee the younger children, middle siblings may concentrate on untouched areas. Even so, they tend to focus more on

relationships than with achievements. In many cases, these

middle children are the ones whom help create a sense of harmony in the family.

61. A. NO CHANGE  
B. buying, or selling  
C. buying, or selling,  
D. buying or selling,
62. F. NO CHANGE  
G. will effect  
H. can effect  
J. can affect
63. A. NO CHANGE  
B. whom  
C. that  
D. OMIT the underlined portion
64. F. NO CHANGE  
G. a responsibility that can be overwhelming.  
H. some children respond poorly to this responsibility.  
J. an expectation that can result in disappointment.
65. A. NO CHANGE  
B. resents  
C. embrace  
D. embraces
66. F. NO CHANGE  
G. areas; even so, they  
H. areas. And they  
J. areas and
67. A. NO CHANGE  
B. about  
C. over  
D. on
68. F. NO CHANGE  
G. who help  
H. whom helps  
J. who helps

The youngest children grow up, surrounded by older  
69

people but typically do not experience early maturation as a result of this positioning. Because thier older siblings are  
70

often responsible for them, youngest children usually remain longer to learn how to be accountable for their own  
71

actions. However, a youngest child's mastery of language and  
72

communication can be advanced due to the adult-centered environment in which she lives.

If then each child were treated equally, there would not be  
73  
substantial differences between oldest, middle, and youngest  
74  
children. And, of course, there are always exceptions to these rules; no child should feel that the characteristics of birth order have been imposed upon him or her. 75 However, in a typical family setting, one will find that those words which make a difference in Monopoly and real estate—location, location, location—can have considerable influence on personality.

69. A. NO CHANGE  
B. The youngest children grow up surrounded by older people  
C. Surrounded by older people, the youngest children grow up,  
D. Surrounded, the youngest children grow up by older people,
70. F. NO CHANGE  
G. Because they're  
H. Because there  
J. Because their
71. A. NO CHANGE  
B. take longer  
C. allow longer  
D. can take the longest amount of time
72. Which of the following alternatives to the underlined portion would NOT be acceptable?  
F. NO CHANGE  
G. Even so,  
H. Nonetheless,  
J. Consequently,
73. A. NO CHANGE  
B. If  
C. If it was the case that  
D. If, then,
74. Which of the following alternatives to the underlined portion would be LEAST acceptable?  
F. NO CHANGE  
G. considerable  
H. discreet  
J. prevalent
75. The writer is considering deleting the underlined sentence. If deleted, the paragraph will primarily lose:  
A. an unnecessary fact that contradicts the essay's main point.  
B. evidence for a point made previously  
C. a concession that balances previous universal statements  
D. details that help link the last paragraph with the first paragraph

END OF TEST 1

STOP! DO NOT TURN THE PAGE  
UNTIL TOLD TO DO SO.

**MATHEMATICS TEST**

60 MINUTES—60 QUESTIONS

**DIRECTIONS:** Solve each problem, choose the correct answer, and then fill in the corresponding oval on your answer document.

Do not linger over problems that take too much time. Solve as many as you can; then return to the others in the time you have left for this test.

You are permitted to use a calculator on this test. You may use your calculator for any problems you choose,

but some of the problems may best be done without using a calculator.

Note: Unless otherwise stated, all of the following should be assumed.

1. Illustrative figures are NOT necessarily drawn to scale.
2. Geometric figures lie in a plane.
3. The word *line* indicates a straight line.
4. The word *average* indicates arithmetic mean.

**DO YOUR FIGURING HERE.**

1. If  $3x + 10 = 22$ , what is the value of  $x$ ?
  - A. 4
  - B. 8
  - C. 16
  - D. 22
  - E. 30
  
2. If a set of numbers  $\{1,1,3,4,5\}$  adds the number 6 to its group, what is the median of the new set of numbers?
  - F. 1
  - G. 2
  - H. 3
  - J. 3.5
  - K. 4
  
3. If it takes 12 hours to drive from New York to Charlotte driving a constant speed, how much of the trip is remaining after 3 hours?
  - A.  $\frac{1}{4}$
  - B.  $\frac{1}{3}$
  - C.  $\frac{2}{3}$
  - D.  $\frac{3}{4}$
  - E.  $\frac{4}{5}$
  
4. If  $y^2 = x^4$  and  $x = 3$ , what is the value of  $y$ ?
  - F. 3
  - G. 6
  - H. 9
  - J. 36
  - K. 81



DO YOUR FIGURING HERE.

5. If  $\log_x 125 = 3$ , what is the value of  $x$ ?
- A. 1
  - B. 3
  - C. 5
  - D. 25
  - E. 125
6. Which of the following lists the fractions  $\frac{1}{2}$ ,  $\frac{2}{3}$ ,  $\frac{2}{9}$ ,  $\frac{1}{4}$ , and  $\frac{3}{5}$  in order from greatest to least?
- F.  $\frac{2}{9}$ ,  $\frac{1}{2}$ ,  $\frac{3}{5}$ ,  $\frac{1}{4}$ ,  $\frac{2}{3}$
  - G.  $\frac{2}{3}$ ,  $\frac{3}{5}$ ,  $\frac{1}{2}$ ,  $\frac{2}{9}$ ,  $\frac{1}{4}$
  - H.  $\frac{2}{3}$ ,  $\frac{3}{5}$ ,  $\frac{1}{2}$ ,  $\frac{1}{4}$ ,  $\frac{2}{9}$
  - J.  $\frac{1}{2}$ ,  $\frac{3}{5}$ ,  $\frac{2}{9}$ ,  $\frac{1}{4}$ ,  $\frac{2}{3}$
  - K.  $\frac{1}{4}$ ,  $\frac{2}{9}$ ,  $\frac{1}{2}$ ,  $\frac{3}{5}$ ,  $\frac{2}{3}$
7. Jason ate lunch at Virginia's Diner. If his meal cost him \$11.00, and he wants to leave Virginia a 15% tip, how much money should Jason leave for the total bill?
- A. \$11.50
  - B. \$12.00
  - C. \$12.36
  - D. \$12.50
  - E. \$12.65
8. The lengths of the sides of a triangle are 3, 5, and 7 inches. How many inches long is the shortest side of a similar triangle that has a perimeter of 75 inches?
- F. 10
  - G. 12
  - H. 14
  - J. 15
  - K. 22



9. Lines  $q$  and  $r$  are parallel lines that are intersected by line  $t$ . What is the measure of angle  $s$ ?

DO YOUR FIGURING HERE.

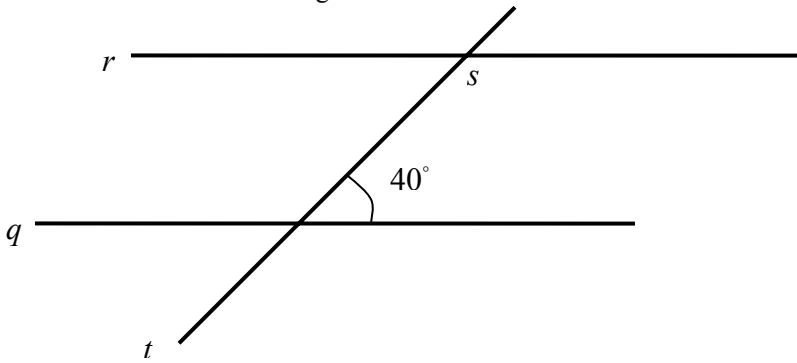

- A.  $40^\circ$   
 B.  $60^\circ$   
 C.  $100^\circ$   
 D.  $120^\circ$   
 E.  $140^\circ$
10. The diagonal of a rectangular yard is 100 feet. One side is 28 feet. What is the perimeter of the yard?  
 F. 56  
 G. 152  
 H. 156  
 J. 248  
 K. 256
11. Mark, Sophia, and Len are waiting in line to buy tickets to a football game. If they are standing in this order, and there are 11 people ahead of Mark and there are twice as many people behind Len as there are ahead of Mark, how many people are in the line for tickets?  
 A. 11  
 B. 22  
 C. 25  
 D. 35  
 E. 36
12. If  $|2x-4| < 8$ , then what is the value of  $x$ ?  
 F.  $x < 6$   
 G.  $-2 < x < 6$   
 H.  $-2 < x$   
 J.  $x > 0$   
 K.  $-2 < x < 4$



13. If 40 is 20% of  $x$ , then  $x = ?$

- A. 80
- B. 100
- C. 160
- D. 200
- E. 400

**DO YOUR FIGURING HERE.**

14. If Cassie's first three test scores are 80, 90, and 91, what is the lowest score she can get on the fourth test and still average at least an 85?

- F. 77
- G. 79
- H. 85
- J. 86
- K. 87

15. In the figure below, what is the area of the shaded region?

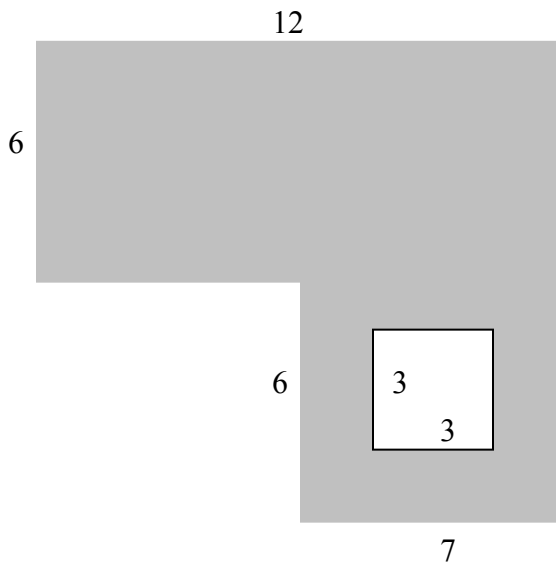

- A. 56
- B. 63
- C. 72
- D. 105
- E. 114

16. If  $a = 3$  and  $b = -1$ , then what is the solution of  $ab - ab^2$ ?

- F. -12
- G. -6
- H. -2
- J. 0
- K. 3



DO YOUR FIGURING HERE.

17. The product of  $(3x^2z)(2xz^4)$  is equivalent to:

- A.  $6x^2z^4$
- B.  $5x^2z^4$
- C.  $6x^3z^5$
- D.  $5x^3z^5$
- E.  $5xz^3$

18. Sally is going on a trip to Oklahoma. When she arrives at the Tulsa airport, she is able to choose between two different rental car companies. Company A charges a fee of \$100 and an additional \$25 for each day that she has the rental car. Company B charges a fee of \$80 plus \$27 dollars for each day she has the car. On which day does Company B become more expensive than Company A?

- F. The 6th
- G. The 8th
- H. The 9th
- J. The 10th
- K. The 11th

19. A radius of the circle below is KL. What is the perimeter of the circle?

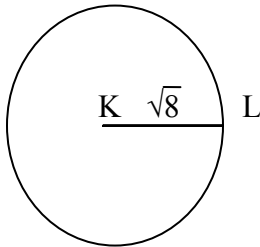

- A.  $4\pi\sqrt{2}$
- B.  $4\pi\sqrt{8}$
- C.  $4\pi$
- D.  $8\pi$
- E.  $16\pi$

20. Which of the following is NOT a factor of  $x^4 - 81$ ?

- F.  $x^2 + 9$
- G.  $x^2 - 3$
- H.  $x^2 - 9$
- J.  $x + 3$
- K.  $x - 3$





**DO YOUR FIGURING HERE.**

21. What is the midpoint of the line segment with endpoints of (2,6) and (-3, 12) ?

- A. (-1,8)
- B. (-5,18)
- C. (-.5,9)
- D. (1,9)
- E. (.5,9)

22. Joe wants to buy a new car, but doesn't know what color to choose. He decides that he is going to choose at random. On the car lot, there are 12 black cars and 5 red cars. There are twice as many white cars as black cars and red cars combined. There are half as many green cars as white cars. And there are three times as many blue cars as red cars. What is the probability that Joe will choose a blue car?

- F.  $\frac{25}{83}$
- G.  $\frac{83}{15}$
- H.  $\frac{17}{65}$
- J.  $\frac{15}{65}$
- K.  $\frac{15}{83}$

23. In order to increase the mean of 6 numbers by 3, what would the total sum of the increase be?

- A. 3
- B. 9
- C. 12
- D. 16
- E. 18



DO YOUR FIGURING HERE.

Use the following information  
to answer questions 24-25.

Below is a chart that shows Garden City's temperatures at each hour during the night:

10 pm	11 pm	12 am	1 am	2 am	3 am	4 am	5 am	6 am
34°	17°	?	4.25°	4.25°	4.25°	14.25°	24.25°	34.25°

24. If prior to 2 am, the temperature dropped at a constant rate, what was the temperature at 12 am ?

- F. 8.5°
- G. 12.75°
- H. 17°
- J. 34°
- K. 40°

25. What was the approximate mean temperature during the night?

- A. -4°
- B. 4°
- C. 16°
- D. 22°
- E. 34°



26. In the isosceles right triangle below,  $MN = 5$ . What is the length of line  $MP$  ?

**DO YOUR FIGURING HERE.**

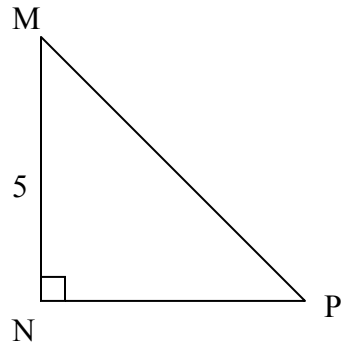

- F.  $5\sqrt{2}$   
 G.  $\sqrt{10}$   
 H.  $5\sqrt{2}$   
 J.  $5\sqrt{10}$   
 K. 25
27. Which of the following has the lowest product?  
 A.  $1 \times \frac{1}{3}$   
 B.  $\frac{9}{2} \times \frac{1}{9}$   
 C.  $\frac{1}{2} \times \frac{1}{4}$   
 D.  $\frac{1}{2} \times \frac{1}{6}$   
 E.  $1 \times \frac{1}{6}$
28. What is the value of  $x^3 - 2x^2 + x - 9$ , when  $x = -2$  ?  
 F. -27  
 G. -18  
 H. -11  
 J. 9  
 K. 13



29. What is the value of  $\csc \alpha$  ?

DO YOUR FIGURING HERE.

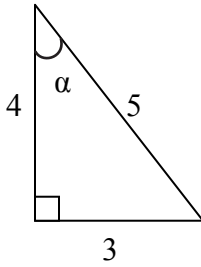

- A.  $\frac{3}{5}$   
 B.  $\frac{3}{4}$   
 C.  $\frac{4}{5}$   
 D.  $\frac{5}{3}$   
 E.  $\frac{4}{3}$
30. A dog eats 6 cans of dog food in 5 days. How many cans of dog food does he eat in  $5+x$  days?  
 F.  $6 + \frac{6x}{5}$   
 G.  $\frac{6+6x}{5}$   
 H.  $\frac{6+x}{5}$   
 J.  $6x$   
 K.  $5x$
31. Line  $s$  passes through points  $w(2, 4)$  and  $z(-6, -10)$ . What is the slope of line  $s$  ?  
 A.  $-\frac{8}{14}$   
 B.  $\frac{4}{7}$   
 C. 3  
 D.  $\frac{14}{8}$   
 E.  $\frac{7}{4}$
32. If  $4^y = 64^{13}$ , what is the value of  $y$  ?  
 F.  $y + \frac{4}{13}$   
 G. 13  
 H. 16  
 J. 39  
 K. Cannot be determined



33. If a number is divisible by both 3 and 12, then that number must be divisible by which of the following?

- A. 5
- B. 6
- C. 18
- D. 36
- E. 48

**DO YOUR FIGURING HERE.**

34. If  $f(x) = 2x^2 + 6$ , what is the value of  $f(3)$  ?

- F. 12
- G. 18
- H. 24
- J. 30
- K. 36

35. Maria wants to put on a piano concert for her 12-year-old daughter to showcase her daughter's talent. Maria will charge adults \$5 and children \$2 for admission. She has agreed to give each of her daughter's friends a 25% discount. If  $a$  stands for the number of adults,  $c$  for the number of children, and  $f$  for the number of friends, which of the following is an equation that shows how much money Maria will make?

- A.  $5a + 2c + f(2 \times .75)$
- B.  $5a - 2c + 2(f + .25)$
- C.  $5a + 2c + (f \times .25)$
- D.  $5a + 2c + 2(f / .25)$
- E.  $5a + 2c + 2f$

36. Julio is building a fence around his rectangular garden to keep rabbits out. His garden extends right up to the back of his house. If his garden begins 10 feet from his house and covers 7 feet across the back of his house, what is the minimum length of fencing will Julio need to protect his garden?

- F. 17 ft
- G. 24 ft
- H. 27 ft
- J. 34 ft
- K. 70 ft

37. In an  $(x,y)$  coordinate plane, what is the slope of  $3-2y = -4 - 2x$

- A. -4
- B. -2
- C.  $\frac{1}{2}$
- D. 1
- E. 2



38. What is the equation of the circle in the standard  $(x, y)$  coordinate plane that has a radius of 5 units and the same center as the circle determined by  $x^2 - 8x + 7 + y^2 = 0$ ?
- F.  $x^2 + y^2 = 25$   
 G.  $x^2 + (y - 4)^2 = 25$   
 H.  $(x + 4)^2 + (y + 4)^2 = 25$   
 J.  $(x + 4)^2 + y^2 = 25$   
 K.  $(x - 4)^2 + y^2 = 25$

**DO YOUR FIGURING HERE.**

39. The operation  $\square$  is defined by the following:  
 $a \square b = 2 + a + b - a \cdot b$   
 For example:  
 $3 \square 4 = 2 + 3 + 4 - 3 \cdot 4 = -3$ .  
 If  $a \square b = b \square a$ , then which of the following describes all the possible values of  $a$  and  $b$ ?
- A. They are both positive.  
 B. They are both negative.  
 C. They are equal.  
 D. They have opposite signs.  
 E. They can have any values.

40. Super Fresh Market wants to divide its produce isle into sections: citrus fruits, berries, and others, with berries being the smallest section. The isle is 64 ft in length and the ratio of the sections needs to be 3:2:3. How much space, in length, will the berries take up?
- F. 2 ft  
 G. 10 ft  
 H. 16 ft.  
 J. 20 ft  
 K. 21 ft

41. Greg rode the train between two cities that were 450 miles apart. There were 6 stops between the two cities. The train stays at each stop for 10 min. If Greg needs to arrive at his destination in less than 4 hours, at least how fast must the train be traveling when it is moving?
- A. 80 mph  
 B. 110 mph  
 C. 135 mph  
 D. 150 mph  
 E. 161 mph



DO YOUR FIGURING HERE.

42. The first value of a geometric series is 4 and the third value is  $16x^2$ . What is the fifth value of this geometric series?
- F.  $8x$   
 G.  $32x$   
 H.  $32x^3$   
 J.  $64x^4$   
 K.  $64x^5$
43. An integer lies between 50 and 500. What are the odds that the integer is a multiple of 5?
- A. 1 : 5  
 B. 89 : 449  
 C. 90 : 449  
 D. 2 : 5  
 E. 90 : 499
44. If  $(x + y)^2 + 3x - y = 64$ , and  $x = 2$ , then what is the value of  $y$ ?
- F. 2  
 G. 5  
 H. 6  
 J. 8  
 K. 14
45. For all nonzero  $a$  and  $b$ ,  $(4a^3b^6)(12a^3b^8) / 8a^6b^7 = ?$
- A.  $6a^3b^{14}$   
 B.  $6b^7$   
 C.  $6ab^7$   
 D.  $8ab^7$   
 E.  $8a^2b$
46. If  $\cot \alpha = y/x$ ,  $x > 0$ ,  $y > 0$ , and  $0 < \alpha < \pi/2$ , then what is  $\sin \alpha$ ?
- F.  $\frac{x}{x^2 + y^2}$   
 G.  $\frac{x}{y}$   
 H.  $\frac{y}{x}$   
 J.  $\frac{x\sqrt{x^2 + y^2}}{x^2 + y^2}$   
 K.  $\frac{\sqrt{x^2 + y^2}}{x}$



DO YOUR FIGURING HERE.

47. A rectangle, not shown, has a length that is 4 times as long as its width. If both of the measurements are tripled, the area of the second rectangle is how many times as large as that of the first?
- A. 4
  - B. 5
  - C. 8
  - D. 9
  - E. 12

48. If  $(x + y)^2 = x^2 + 16x + z$ , and  $y$  and  $z$  are integers, what is the value of  $z$ ?
- F. 8
  - G. 16
  - H. 24
  - J. 36
  - K. 64

49. For the right triangle below, which of the following expressions is equal to  $\cot \theta$ ?

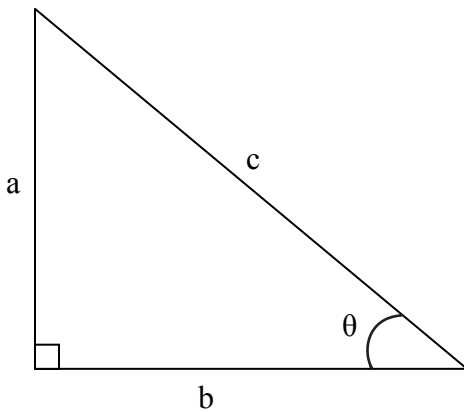

- A.  $\frac{a}{b}$
- B.  $\frac{b}{a}$
- C.  $\frac{a}{c}$
- D.  $\frac{c}{a}$
- E.  $\frac{c}{b}$





DO YOUR FIGURING HERE.

50. In the figure below, a circle with a diameter of  $2r$  is inscribed in a square.  $B$  is on both the circle and the line segment  $\overline{AC}$ . What is the distance of line segment  $\overline{BC}$ , in terms of  $r$ ?

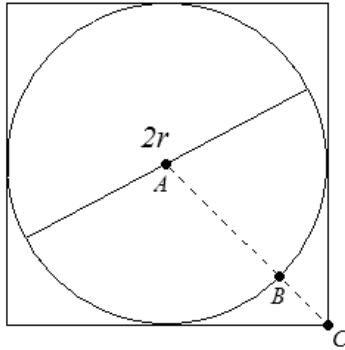

- F.  $r/2$   
 G.  $r\sqrt{2} - r$   
 H.  $r\sqrt{2}$   
 J.  $2r$   
 K.  $r + \pi$

51. The figure below shows 2 circles such that the 4 inch diameter of the smaller circle is equal to half the diameter of the larger circle. What is the area, in square inches, of the shaded region?

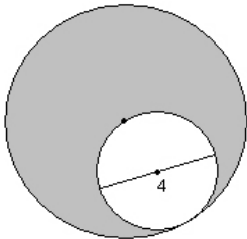

- A.  $4\pi$   
 B.  $12\pi$   
 C.  $16\pi$   
 D.  $48\pi$   
 E.  $56\pi$



52. The third number in a sequence is 6 and every term in the sequence is 5 more than the term immediately preceding it. What is the value of the 101<sup>st</sup> term?
- F. 491  
G. 496  
H. 501  
J. 506  
K. 511

**DO YOUR FIGURING HERE.**

53. If  $a < b$ , which of the following must be true?
- A.  $ab < b^2$   
B.  $a^2 < b^2$   
C.  $2a > \frac{1}{2}b$   
D.  $-b < -a$   
E.  $2a + b < 2b$

54. If  $\log_a x = b$  and  $\log_a y = c$ , then  $\log_a(x/y) = ?$
- F.  $b/c$   
G.  $a - b$   
H.  $b - c$   
J.  $a/b$   
K.  $b^x$

55.  $N$  families agree to contribute equally to a gift for a teacher that costs  $D$  dollars. If  $P$  of the families fail to contribute, which of the following represents the amount, in dollars, that each of the remaining families must contribute to pay for the gift?
- A.  $D/N$   
B.  $D/(N-P)$   
C.  $N/D$   
D.  $(PD)/N(N-P)$   
E.  $D(N-P)/N$

56. Let  $f(x) = x^2 - 3$  for all real values of  $x$ . What is  $\frac{1}{2}f(\sqrt{y})$ ?
- F.  $y/2$   
G.  $(y-3)/2$   
H.  $(y+3)/2$   
J.  $(\sqrt{y}-3)^2/2$   
K.  $y$

57. The expression  $(\cos^2\theta + 1 - \sin^2\theta) / (2 \sin\theta\cos\theta)$  is equivalent to which of the following?
- A. 2  
B.  $-\sin\theta\cos\theta$   
C.  $\tan\theta$   
D.  $\sin\theta\cos\theta/2$   
E.  $\cot\theta$



DO YOUR FIGURING HERE.

58. A plane spends ten percent of its airtime climbing to its height destination of 36,000 ft. During this time, the airplane travels an average speed of 320 miles/hr. It then spends another ten percent of its airtime descending from 36,000 ft. at an average speed of 340 miles/hr. If the airplane's average speed in the air, from take-off to landing, is 400 miles/hr. What was the average traveling speed of the aircraft during its time at 36,000 ft?
- F. 353.3 miles/hr  
 G. 375 miles/hr  
 H. 405.75 miles/hr  
 J. 417.5 miles/hr  
 K. 421.25 miles/hr

59. In the figure below, AB is a diameter of the circle with center O, r is the radius of the circle, and ABCD is a square. What is the area of the shaded region in terms of r?

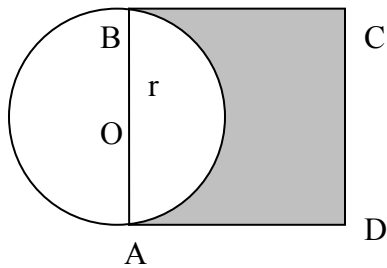

- A.  $\pi(r^2 - 2)$   
 B.  $\pi(2 - \pi)$   
 C.  $r^2(\pi - 2)$   
 D.  $r^2(4 - \pi/2)$   
 E.  $r^2(2 - \pi/4)$
60. If  $rt \neq r$  and  $t = 1/r$ , which of the following expressions is equivalent to  $\frac{2(1-r)}{(t-1)}$ ?
- F.  $^{-1}/_2r$   
 G.  $-2t$   
 H.  $2r$   
 J.  $^{1/2}r/_2t$   
 K.  $-t$

END OF TEST 2  
 STOP! DO NOT TURN THE PAGE  
 UNTIL TOLD TO DO SO.

**READING TEST**  
35 Minutes—40 Questions

**DIRECTIONS:** There are four passages in this test. Each passage is followed by several questions. After reading a passage, choose the best answer to each question and fill in the corresponding oval on your answer document. You may refer to the passages as often as necessary.

**Passage I**

**PROSE FICTION:** This passage is adapted from *Ex Libris: Confessions of a Common Reader* by Anne Fadiman (©1998 by Anne Fadiman).

Long ago, when George and I were not yet married but seemed to be tottering in that general direction, we gave each other our first Christmas presents. Of course, they were books. This now seems very fitting since we  
5 both went on to be published authors. Sometimes I think that it was our love of books that drew us to one another. Knowing that I liked bears, George gave me *The Biography of a Grizzly*, by Ernest Thompson Seton. Modestly sequestered on the third page was the following  
10 inscription: *To a new true friend*. No Talmudic Scholar, no wartime cryptographer, no deconstructionist critic ever scrutinized a text more closely than I did those five words, hoping that if they were just construed with the right emphasis, they would suddenly reveal themselves as  
15 a declaration of undying devotion.

Knowing that George liked fish, I gave him *Old Mr. Flood*, by Joseph Mitchell, a slim volume of stories about the Fulton Fish Market. The author had autographed the book himself in 1948, but did I leave well enough alone?  
20 Of course not. I wrote: *To George, with love from Anne*. Then I mistranscribed a quotation from Red Smith. And finally—on the principle that if you don't know what to say, say everything—I added fifteen lines of my own reflections on intimacy. My cumulative verbiage, not to  
25 mention the potency of my sentiments, exceeded George's by a factor of approximately twenty to one. It's a miracle that the book, its recipient, and the new true friendship weren't all crushed under the weight of the inscription.

George married me anyway and has retained his affection for both fish and Joseph Mitchell. My words were preserved for good. Unlike the card that accompanies, say, a sweater, from which it is soon likely to part company, a book and its inscription are  
35 permanently wedded. This can be either a boon or a blot. My inscription did not improve *Old Mr. Flood* in the same way that, for example, *To Miss Elizabeth Barrett with the Respects of Edgar Allan Poe* improved *The Raven and Other Poems*. However, with each book

40 bought as a present, I continue to inscribe my own words on the flyleaf of the book.

Proper inscription etiquette is done on the flyleaf instead of the title page, which is traditionally reserved for a book's author. I learned this only recently, after having  
45 defaced dozens of other writers' title pages. I should have cracked the code years ago, since the Books by Friends and Relatives section of our own library contains a profusion of title-page inscriptions, all illicitly deployed. My father inscribed *Famous Monster Tales*, an anthology  
50 to which he contributed a preface when I was a sullen fourteen-year-old, *For Anne, from that old monster, Daddy*.

A distant rung down from the "presentation copy"—an inscribed book actually presented by the author as a gift—is the "inscription copy," a book inscribed at the  
55 owner's request. Before the advent of store-sponsored book signings, most readers got a book inscribed by mailing it to the author and praying that it would make a round-trip. Yeats once asked Thomas Hardy how he handled these requests. Hardy led Yeats upstairs to a large room that was filled from floor to ceiling with books—  
60 thousands of them. "Yeats," said Hardy, "these are the books that were sent to me for signature."

Maggie Hivnor, the paperback editor of the  
65 University of Chicago Press, once told me that when she adds an out-of-print title to her list, she calls the author and asks for a pristine copy that can be photographically reproduced. "The author is usually a man," she explained. "In a few weeks, a beautifully kept copy of his book  
70 arrives, a little dusty perhaps but otherwise absolutely perfect. And on the title page it invariably says *To Mother*."

Now *that's* a real inscription. The best thing about it is that until the editor's call, the book that it ennobled  
75 reposed precisely where it should have: in a place of honor on Mother's shelf. And there it shall return. How melancholy, by contrast, are the legions of inscribed copies one finds in any used-book rack, each a memorial to a betrayed friendship. Do the traitors believe that their  
80 faithlessness will remain a secret? If so, they are sadly deluded. Hundreds of people will witness it, including, on occasion, the inscriber. Fortunately, the very finest

inscriptions, like the finest love letters, rarely pass out of a family.

- 85 The best inscription *I've* ever gotten is on the title page of *The Enigma of Suicide*, by George Howe Colt. It reads (how far we have come, George, since our true friendship!) *To my beloved wife...This is your book, too. As my life, too, is also yours.*
- By using the word *verbiage* (line 24) to describe her inscription, the author implies that her inscription was:
    - sensitive.
    - emotional.
    - verbose.
    - in love.
  - Which of the following would the author most likely agree with?
    - Inscription writing is more personal than buying a card.
    - Inscriptions are often misplaced, lost, or discarded.
    - The importance of inscriptions is exaggerated.
    - It is easier to inscribe a book than to invest in a card.
  - This passage is best described as being:
    - an analysis of the relationship between two writers.
    - an explanation of the art of inscription writing.
    - an argument supporting the purchase of books as gifts.
    - a personal commentary on the art of inscription writing and how it can reflect on a relationship.
  - According to the passage, why is it customary to inscribe on the flyleaf of a book as opposed to the title page?
    - Some books do not have title pages.
    - There is more room to write on the fly leaf than on the title page.
    - The title page is set aside for the author's inscription.
    - The fly leaf is traditionally reserved for handwritten prefaces.
  - Lines 10-15 imply that the author:
    - did not believe that her boyfriend's words were true.
    - scrutinizes all inscriptions.
    - deeply analyzed her boyfriend's inscription.
    - wished her boyfriend had written a longer inscription.
  - The fifth paragraph (lines 53-63) establishes that before in-store book signings, authors often:
    - had to hire someone to sign all of the books that people sent them.
    - did not have time to put their signature on every book that they were sent.
    - did not print as many copies of books as they do now.
    - did not choose to personally inscribe their books for fans.
  - According to the author, the act of selling or giving away a book inscribed by a friend is to:
    - betray that friendship.
    - give a price to that friendship.
    - regret that friendship.
    - deny that friendship.
  - Why does the author refer to the success of her relationship as a "miracle" (line 27)?
    - to stress the serious implications of his gift.
    - to hint at divine intervention.
    - to poke fun at her own mistake.
    - to illustrate the wonder of love.
  - When the author writes "This can be either a boon or a blot." (line 35), she is saying that the wedding of an inscription and a book:
    - can permanently accentuate or detract from the gift.
    - definitely has its disadvantages.
    - can improve or impair the physical state of the book.
    - can be appreciated and loathed.
  - melancholy (line 77) most nearly means:
    - tattered
    - undignified
    - sad
    - neglected

## Passage II

**SOCIAL SCIENCE:** This passage is adapted from an article in *Star City Sports* by Ransdell Putnam (©2002). WNBA stands for Women's National Basketball Association.

Television is the mother's milk of big-time, high-revenue sports. With television, the WNBA is successful. Without it, volleyball struggles for attention. Television rights fees help pay for college athletic departments and huge pro salaries. As much as you may love big-time sports, consider the social impact of its marriage partner: television, America's encouraged addiction.

According to a 1999 A.C. Nielsen survey, an average two-to-eleven-year-old child spends more than 31 minutes with TV to every one minute of meaningful conversation with mom and dad. Eighty-one percent of fourth graders watch more than two hours of TV a day. While just thirty minutes of practice a day for a few years can make a young person more than proficient at a musical instrument, the average American child, ages two to 11, watches television 2.85 hours a day. If you assume eight hours a day of sleep and 16 hours of consciousness, that's 65 full days of consciousness per year consumed by TV, more than two months. And for every three hours of school instruction, our kids average five hours of TV. Also, these TV viewing numbers do not include Internet or computer game use. We condition our young to watch. Or deferring to modern jargon: we enable. An addiction? How about an epidemic.

Twenty-five percent of two to 11 year olds have TVs in the bedroom. So one-fourth of kids at that tender age have parents who give TV intimate access to the child. Even more surprising is that a spring 2005 USA Today poll found that America's youth demand television access. Therefore, a staggering 68 percent of Americans, age eight through eighteen, have a TV in the bedroom. Twenty-five percent of teenagers, ages 13 to 17, can tell you where the US Constitution was written, while 75 percent of teenagers know where you find the zip code 90210. The average American child watches TV commercials for more than the equivalent of ten full, non-stop days a year. Sports programming helps make TV captivating and addictive.

A summer 1999 report by the American Academy of Pediatrics reads: "TV can harm children. Babies and toddlers need direct interaction with parents and other caregivers to develop mentally, socially, and emotionally, and if they're watching TV, they're not getting that interaction." The pediatrics academy goes on to say that kids should not have TVs or computers in their bedrooms.

A September 1999 Brown University study linked TV viewing by children with sleep deprivation. The researchers say that TV stimulates children, while parents may view it as sedating and may not realize the irony. These researchers recommend a cool down or reading period for children before bed.

Other studies have linked television with depression, apathy, paranoia, aggression, dangerous copycat behavior, sexual promiscuity, poor school performance, obesity, reduced attention spans, and poverty. In fact, the cycle of poverty, the inter-generational grip poverty has on thousands of American families, is often related to excessive television viewing and its dampening effects on motivation.

But some might argue that watching Michael Jordan inspires kids from the couch towards the playgrounds and gyms. Yet after TV, the internet, and computer games, just how much waking time remains for exercise? And the current childhood obesity epidemic suggests that we have a perfect storm: the confluence of TV, fast food, and absent parents.

The deleterious effects of television are not wasted just on the young. Again, according to the A.C. Nielsen Company: 66 percent of US families regularly watch TV while eating dinner—two thirds! By age 65 the average American has spent nearly nine years glued to the tube, logged an average of nearly 4 hours a day, almost 52 days of non-stop viewing a year, and has spent almost two full, non-stop years of life watching TV commercials.

Many TV devotees view sports as one of the good things on TV. This is the defense used by many. And they're right. Healthy programming does exist—C-Span, the History and Learning channels, and Public Television can teach a lot. But inevitably the thumb gets trigger-happy and the surfing begins. And even if you and all your family members stay disciplined on the good stuff, the hours accumulate. Are the joys of good TV equal to the joys of many of the alternatives, including music, playing sports, reading, and conversation? Do the few examples of healthy programming truly outweigh all the drawbacks?

Mountains of evidence suggest that the American family itself would greatly benefit from no more than one television in every American home. In all the serious research studies done with people on their death beds, no one has ever stated a regret that he watched too little TV.

11. What concept does the author use the research of the American Pediatrics Academy to support?
- A. That television watching thwarts children's musical talents.
  - B. That television watching causes sleep deprivation in children.
  - C. That television watching negatively affects the mental, social, and emotional development of children.
  - D. That time spent watching television is inversely related to a child's IQ.
12. Why does the author refer to television and big-time sports as a married couple?
- F. Because television fees subsidize college athletic departments.
  - G. He thinks that college athletic departments financially rely too often on television revenues and not enough on ticket sales.
  - H. Because without television, big-time sports would not exist.
  - J. Because athletes get more air time on television than politicians do.
13. The above passage can best be described as:
- A. One person's view of the negative effects of watching television versus the benefits of reading.
  - B. A thorough analysis of children's television watching habits.
  - C. A historical explanation of television and its affects on society.
  - D. An opinion piece citing a compilation of studies that support the claim that television has harmful effects on the population as a whole.
14. Which of the following pieces of evidence, if true, would most weaken the author's primary argument?
- F. Avid reading is strongly correlated with stomach ulcers, poor eyesight, and antisocial behavior.
  - G. Over half of the time high school students spend watching television is done with friends or family.
  - H. Fewer televisions were stolen last year than in the two previous years combined.
  - J. The amount of television watched every week is statistically independent of time consumed by work, sleep, exercise, or social interaction.
15. Which of the following would the author most likely agree with?
- A. TV, though not completely unhealthy, harms much more than it helps.
  - B. Television inspires young people to achieve.
  - C. Television is an encouraged addiction that should be purged from all American homes.
  - D. TV and sports are good for each other.
16. What is the best explanation for why the author refers to television as "America's Encouraged Addiction" (line 7)?
- F. Because televisions have such a dominating presence inside homes.
  - G. Because new studies reveal that televisions may encourage addictive behavior in kids.
  - H. Because television dampens motivation.
  - J. Because television, despite countless negative outcomes associated with its use, endures no social stigma
17. It can be inferred that the author acquired his opinion about television by:
- A. watching television himself.
  - B. talking to child psychologists.
  - C. researching statistics about television watching in America.
  - D. performing studies that examine how often children watch TV.
18. Which of the following does the author NOT include as a harmful effect of watching television?
- F. Compromised academic performance
  - G. Apathy
  - H. Poor diction
  - J. Aggression
19. According to the passage, it can be inferred that, when it comes to television, the author is:
- A. contemptuous.
  - B. disinterested.
  - C. complementary.
  - D. ambivalent.
20. Which of the following most accurately describes the main point of the second to last paragraph (lines 75-86)?
- F. Although healthy programming does exist on TV, the alternatives may be better.
  - G. There should be a one television limit in all homes in America.
  - H. Sport programs on television encourage kids to exercise and compete in athletics.
  - J. Watching healthy TV programs is just as beneficial as the alternatives.

## Passage III

**HUMANITIES:** This passage is authored by George Colt  
 (©2005, George Colt).

The Pilgrims come from Rhode Island, from Iowa, from Texas. Driving north along the Maine coast, they smile with recognition at the weathered old barns, the iron-gray ocean, the fields spangled with goldenrod and Queen Anne’s lace. When a split-level ranch house intrudes, they frown. It doesn’t fit their picture. The road crests through a dark stand of pine, and there, on a knoll high above the Atlantic, they finally glimpse the reason they have traveled all those miles: a decrepit 18<sup>th</sup> century clapboard farmhouse.

One art historian has called this ramshackle structure America’s Parthenon. America’s Lourdes might be more apt. People come here not to inspire the intellect but to salve the soul. Some write poems, some sketch, some leave flowers. Some walk down the hill and kneel—in a never quite successful attempt to imitate that famous, awkward, yearning pose—where they think she knelt. The Painting is not here; it resides at the Museum of Modern Art in New York City. But in the gift shop, visitors can linger before dozens of reproductions—on postcards and posters—of *Christina’s World*, painted in 1948 on the second floor of this house.

Before they leave, the pilgrims hover over the guest book to pour out their feelings to the man who transformed Christina Olson, crippled daughter of a Swedish sailor, into a symbol of pain and longing: “This is like visiting Assisi and touching the stones that Francis touched.” “You have been part of my life for over thirty years.” “Thank you for being America’s painter.”

In an age when many people would be hard-pressed to name one other living American artist, Andrew Wyeth is so well known that he has achieved mythic, indeed beatified, stature. The characters in his paintings have become icons, and the places where they were painted have become secular shrines. He is surely the only American artist whose name, mutated into an adjective, is used to boost real-estate sales. His critics can be withering. “Nostalgic” and “vacuous” are among their putdowns, when they deign to consider him at all. But as the catalogue of a recent Wyeth exhibit—titled, of course, America’s Painter—put it, “Say what we will about art; Wyeth can take your breath away.”

And the people whose breath has been taken away feel possessive. If Wyeth is America’s Painter, that means he is theirs. Many of the entries in the Olson House guest book begin not “Dear Mr. Wyeth” but “Dear Andy” and sound as if the writers expect the artist to read them every

night—as if he lived in the museum, instead of on a remote island eight miles away. Because they know the paintings so well, people believe they also know the painter. They assume that his character is as serene as one of his landscapes. But they might be surprised at the multiplicity of selves that lie like layers of impasto over the essential, unknowable core.

As I travel north to spend a day with Andrew Wyeth, I find myself thinking of a story I’d read. One Halloween, Wyeth, whose love of disguises is legendary, wore a gorilla mask. When he opened the door to a pack of young trick-or-treaters, they became frightened. “Don’t worry,” he said. “I’ll take off the mask.” He removed the gorilla mask. Underneath, his face and hair were painted skull white. A glass eye was affixed to his cheek.

To reach Wyeth’s island, I take a boat from Port Clyde, a lobstering village across the St. George River from Cushing, where the Olson House is located. Wyeth has spent every summer since he was a child in the fields and waters near here, a region one aide calls “Wyeth North.” Two years ago, he and his wife moved four miles offshore to Benner Island, an uninhabited speck too tiny to appear on most maps. Bill Stuart, a Wyeth employee, steers the 25-foot Boston Whaler through waters speckled with lobster buoys. Every six seconds or so, I hear a foghorn’s baleful moo. And then Benner Island, rugged and rock-strewn, appears out of the fog. Standing alone on a long wooden wharf is Wyeth.

He wears a navy peacoat over a gray turtleneck sweater and white jeans spattered with gray paint. The Maine sun has tanned him to a caramel hue, his face as weather-beaten as a Wyeth barn. His light blue eyes glitter from behind heavy lids. When I shake his hand, I notice he has surprisingly long, thin fingers, and that the moons of the nails are encrusted with dried paint. Although he is nearly six feet tall, he seems smaller. His face has an elfin quality, abetted by rather large ears. One of his best-known techniques is painting the complete background so that the figure, when finally superimposed, seems to pop out of the landscape. Wyeth himself is so full of spirit and spark that he, too, seems to pop out of his surroundings.

21. The main purpose of the third paragraph (lines 23-29) is to:
- describe the importance of Wyeth’s painting, *Christina’s World*.
  - explain the possessive feelings that many of Andrew Wyeth’s admirers have.
  - compare Andrew Wyeth to Francis of Assisi.
  - convey the deep feelings that Andrew Wyeth’s admirers have for him.



22. As it is used in lines 32-33 the phrase *mythic, indeed beatified, stature* most nearly means that Wyeth is:
- F. popular and admired.
  - G. a legend.
  - H. a fictitious character exalted by his fans.
  - J. a talented artist.
23. Which of the following most accurately describes how Wyeth's fans perceive him?
- A. Uncomplicated
  - B. Dry
  - C. Pensive
  - D. Forthright
24. The author most likely uses paragraph six (lines 55-62) to tell a story about Wyeth in order to imply that:
- F. Wyeth's love of disguises is legendary.
  - G. he understands Wyeth's unpredictable personality.
  - H. young people are scared of Andrew Wyeth.
  - J. perhaps Wyeth's fans don't know him as well as they think.
25. Where is the original painting, *Christina's World*, displayed?
- A. At the Wyeth museum in Maine.
  - B. At Wyeth's new home on Benner Island.
  - C. At the Museum of Modern Art in New York City.
  - D. At Andrew Wyeth's childhood home: "Wyeth North."
26. Why are the pilgrims that come to visit the birth place of *Christina's World* disappointed when they see a split-level ranch house?
- F. They do not like split level houses.
  - G. They think that it should be the decrepit 18<sup>th</sup> century clapboard house.
  - H. They expect only to see the serene and peaceful landscape that inspired the painting.
  - J. Split-level ranch houses produce feelings of nostalgia, making them want to return home.
27. When the author states that "One art historian has called this ramshackle structure America's Parthenon" (lines 11-12) what is this art historian most likely suggesting?
- A. That this farmhouse has had dramatic effects on American culture throughout American history, as is the case with the Parthenon throughout Greek history.
  - B. That the Andrew Wyeth museum is characterized by its religious significance.
  - C. That people flock to this farmhouse year after year, just as they do to see the Parthenon.
  - D. That this farmhouse has suffered from the ravages of time, just as is the case with the ancient Parthenon in Athens.
28. As implied in the passage, why do people travel hundreds of miles to see a dilapidated 18<sup>th</sup> century clapboard house?
- F. To see the setting for Andrew Wyeth's famous painting, *Christina's World*.
  - G. To visit Andrew Wyeth's gift shop and to tell him how much he means to them.
  - H. To see Andrew Wyeth, though they rarely do.
  - J. All of the above.
29. The last paragraph (lines 76-88) can most accurately be described as:
- A. a physical description of Andrew Wyeth and his surroundings.
  - B. a comparison between Andrew Wyeth and his paintings.
  - C. the author's opinion of Andrew Wyeth and his paintings.
  - D. an explanation of Andrew Wyeth's painting techniques.
30. The author uses all of the following to describe the importance of Andrew Wyeth EXCEPT:
- F. opinions from Wyeth's fans.
  - G. a quotation from the catalogue of a recent Wyeth exhibit.
  - H. evidence of the impact that his paintings have had on the American population.
  - J. a discussion that the author had with Andrew Wyeth.

## Passage IV

**NATURAL SCIENCE:** This passage is authored by Joel Keralis (©2005, Joel Keralis).

Most people associate the term *entomology* (the study of insects) with bug-spraying and butterfly-collecting. In reality, however, entomology affects society in a tangible and practical sense—extending  
5 beyond the dark corners of basements and the collections of bug enthusiasts.

Entomology is the study of species from the animal class Insecta. Insects typically have hard, chitinous exoskeleton that protects their delicate inner organs. This hard covering gives the insect’s tri-segmented body all the  
10 support that an ossified endoskeleton provides a human. Insects are well equipped for a variety of mobile activities with jointed appendages like their two antennae, four  
60 wings, and six legs.

Insects are among the most numerous classes in the  
15 animal kingdom with as many as 20 to 30 million species grouped by physical characteristics into approximately 29 major orders. It is this titanic number of organisms and the amazing diversity among the many species that has allowed the class to prosper since time began.

In recent years, one of entomology’s practical applications—forensic entomology—has received some glamour on popular crime-drama television shows. These programs often depict the expertise of a forensic entomologist, who helps examine evidence from a crime  
25 scene. A skilled forensic entomologist can tell almost exactly how long a body has been dead simply by analyzing the insects that are found on the corpse. The insects on a corpse can also lend information to the time of day that the death occurred, the manner of the death,  
30 and the location of the killing.

Agriculture science has also substantially benefited from the knowledge gained by entomology. Insects are major causes of damage to crops and livestock, and their control is necessary for the maximization of profit by an  
35 agricultural organization. Many types of insects feed on food crops and can sometimes even destroy an entire crop. For instance, in the Dust Bowl era, locust swarms were massive enough to blot out the sun and were capable of eating an entire field clean in one sitting. Now, through  
40 advancements in our understanding of insects and in our methods of extermination, we are able to control the locusts to the level at which they are no more than a minor hindrance.

Yet another important scientific application of  
45 entomology has been in the field of medicine. In the past,

diseases transmitted by insects like bubonic plague, malaria, and yellow fever were major killers in the United States as well as around the world. Fortunately, entomologists were able to determine the specific insects  
50 that transmitted these deadly diseases. Then, by studying these insects and diseases, entomologists were able to find more appropriate and effective ways to both treat diseases and eliminate the threat of the disease by controlling the populations of the insects that transmit the diseases. Thanks  
55 to their work, these diseases have been almost completely removed from the United States. West Nile Virus, transmitted by mosquitoes, presents a new, unsolved challenge for entomologists in the U.S. and abroad.

The applications of entomology exist outside of the science lab, as well. In fact, we come into contact with entomology frequently in our daily lives. You don’t think  
60 about the entomological research that went into the development of DEET when you put on some bug spray, but you trust its effectiveness nonetheless. In the same way, you don’t necessarily consider how ladybugs benefit your garden, or why insects are so attracted to your porch  
65 lights at night. Nonetheless, all of these phenomenon affect your life whether or not you understand the entomological science behind them.

The prevailing opinion of the general public is probably that “the only good insect is a dead insect.” This mindset often results in the overuse of pesticides and bug sprays. Usually, these chemicals are deployed at the  
70 slightest threat of an insect, often causing more damage than good because the pesticides also kill many beneficial insects that are actually helping you in a variety of different ways. Remember that applying poison is not  
75 always the best method of rectifying a problem with insects. If pesticides do need to be applied, it is most important to follow the directions on the pesticide’s label.

The most important thing to remember regarding  
80 insects is that almost all of them are completely harmless, and even the few that are capable of a semi-painful sting or bite will typically not attack unprovoked. It is not necessary to avoid a bee or a wasp at all costs. As long as  
85 you ignore it, it will almost always ignore you. Do not make any sudden or threatening movements. Of course, when in doubt, always call a professional entomologist.

31. According to the passage, an insect’s exoskeleton is made of what material?
- A. Bone
  - B. Chitin
  - C. Ossius
  - D. Cartilage

32. To allow for movement, an insect's appendages are:
- F. jointed.
  - G. stiff.
  - H. whip-like.
  - J. bony.
33. According to the passage, which of these are important branches of entomology?
- I. Agricultural
  - II. Forensic
  - III. Dietary
  - IV. Medical
- A. I and II Only
  - B. II and III Only
  - C. I, II, and IV Only
  - D. I, II, III, and IV
34. According to the passage, the Dust Bowl era reinforced what concern?
- F. That locust swarms have the ability to devastate an entire crop.
  - G. That insects can be lethal, destroying crops and harming livestock.
  - H. That locust swarms have the ability to blot out the sun.
  - J. All of the above.
35. Which of the following statements is implied in the author's discussion of forensic entomology (lines 20-30)?
- A. The location of insects on a corpse is irrelevant for determining time of death.
  - B. If it were a useful tool of investigation, forensic entomology would not have captured the public's interest.
  - C. Forensic entomology's utility as a crime-solving tool is dependent on the proficiency of the investigator.
  - D. The recent flurry of attention given to forensic entomology obscures its actual importance.
36. According to the passage, insects found on a corpse can tell a forensic entomologist:
- F. approximate time of death.
  - G. the manner of the death.
  - H. how long the corpse has been dead.
  - J. All of the above.
37. What does the passage say is a common link among the diseases of malaria, yellow fever, and bubonic plague?
- A. They are insect-transmitted diseases that have killed many people but have since been brought under control in the United States.
  - B. They are insect-transmitted diseases that kill thousands of Americans every year.
  - C. They are insect-transmitted diseases that have been eradicated through entomologic research.
  - D. They are insect-transmitted diseases, which are no longer a threat because of newly discovered vaccines.
38. Which of the following titles best captures the purpose of the essay?
- F. Advantageous Insects
  - G. The World of an Entomologist
  - H. Everyday Entomology
  - J. Insects and Agriculture
39. What is the main point of the eighth paragraph (lines 68-79)?
- A. Pesticides, though helpful, can be harmful if misused.
  - B. Pesticides should never be used by non-professionals.
  - C. Pesticides kill advantageous insects.
  - D. "The only good insect is a dead insect."
40. According to the passage, which of these statements about stinging insects is TRUE?
- F. Stinging insects are particularly dangerous because they are aggressive.
  - G. Do your best to stay away from all stinging insects.
  - H. Defend yourself by moving to scare them away.
  - J. If you leave them alone, they will leave you alone.



**SCIENCE TEST**

35 Minutes—40 Questions

**DIRECTIONS:** There are seven passages in this test. Each passage is followed by several questions. After reading a passage, choose the best answer to each question and fill in the corresponding oval on your answer document. You may refer to the passages as often as necessary.

You are NOT permitted to use a calculator on this test.

**Passage I**

The oceans of Earth exist in various types of climates around the world and consequently have different physical properties within their depths, such as temperature and light penetration. Deep oceans can be divided into zones based on their temperature gradient and the depth to which sunlight penetrates the water. Figure 1 shows the zones of a typical deepwater ocean (zone depth boundaries are given in meters (m)).

Sound waves are used to measure ocean temperature at different depths. Figure 2 shows the various water temperatures at different depths in Celsius (C) in warmer tropical oceans, cool temperate oceans, and frigid arctic oceans.

The sound wave measurements of temperatures from two different ocean regions are recorded in Table 1.

**Figure 1**

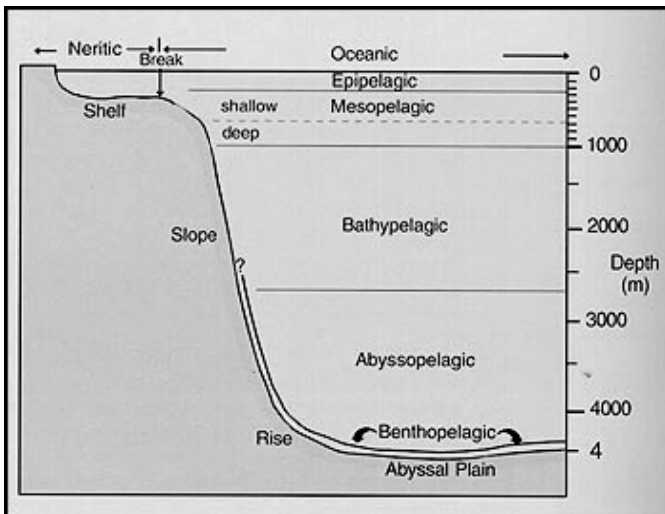

**Figure 2**

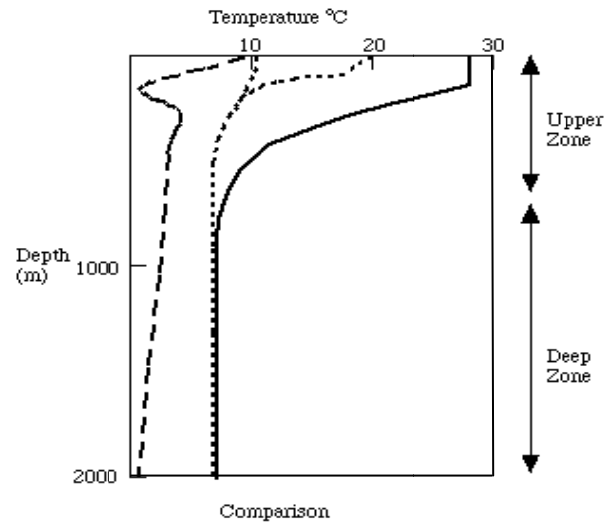

**Key**

- tropical ocean
- ..... temperate ocean
- - - arctic ocean

**Table 1**

Table 1			
Total Pressure (kPa)	Depth (m)	Ocean Temperature (C)	
		Region 1	Region 2
101	0	27	10
200	102	26	6
300	202	21	3
400	302	20	4
500	402	18	4
600	501	16	3



1. According to Figure 1, the regions of several ocean zones overlap as one moves down the ocean floor. Which of the following parts of the topography of the ocean floor share part of a common depth range?
  - A. The slope is both bathypelagic and epipelagic.
  - B. The slope is both mesopelagic and bathypelagic.
  - C. The rise is both epipelagic and mesopelagic.
  - D. The abyssal plain is both benthopelagic and mespelagic.
2. According to Figure 1, an oceanographic temperature reading taken from the abyssopelagic zone will likely have which of the following depths?
  - F. 1000 m
  - G. 2000 m
  - H. 3000 m
  - J. 5000 m
3. According to Figure 2, a sonographic measurement of temperature would be unable to distinguish the difference between tropical and temperate oceans at which of the following depths?
  - A. 10 m
  - B. 250 m
  - C. 500 m
  - D. 1000 m
4. According to Table 1, the relationship between depth and ocean temperature is best described by which of the following statements?
  - F. The water temperature increased with increasing depth in Region 1 only.
  - G. The water temperature decreased with increasing depth in Region 1 only.
  - H. The water temperature increased with increasing depth in Region 2 only.
  - J. The water temperature decreased with increasing depth in Region 1 only.
5. According to Table 1, if water temperature measurements were taken at a depth of 600 m, the total pressure at that depth would most likely:
  - A. decrease to less than 101 kPa.
  - B. remain consistent at 600 kPa.
  - C. increase to approximately 700 kPa.
  - D. increase to approximately 1000 kPa.
6. Marine biologists have discovered a single-celled water creature that is highly sensitive to temperature changes. The creature can only exist in water that has a temperature of 20° C. In which of the following ocean climates and at what depth would this creature most likely thrive?
  - F. only near the surface of temperate waters.
  - G. in both temperate and tropical waters at a depth of 1000 m.
  - H. in tropical waters near the surface and in temperate waters at a depth of approximately 250 m.
  - J. in temperate waters near the surface and in tropical waters at a depth of approximately 250 m.

## PASSAGE II

Electromagnetic radiation, commonly known as “light”, is found on a spectrum of different wavelengths ranging from high energy gamma rays with wavelengths as small as  $10^{-6}$  nm and as large as radio waves with wavelengths of up to 100 km. While the wavelengths of visible light are necessary for the human sense of sight, other wavelengths have been used by humans for a wide variety of uses.

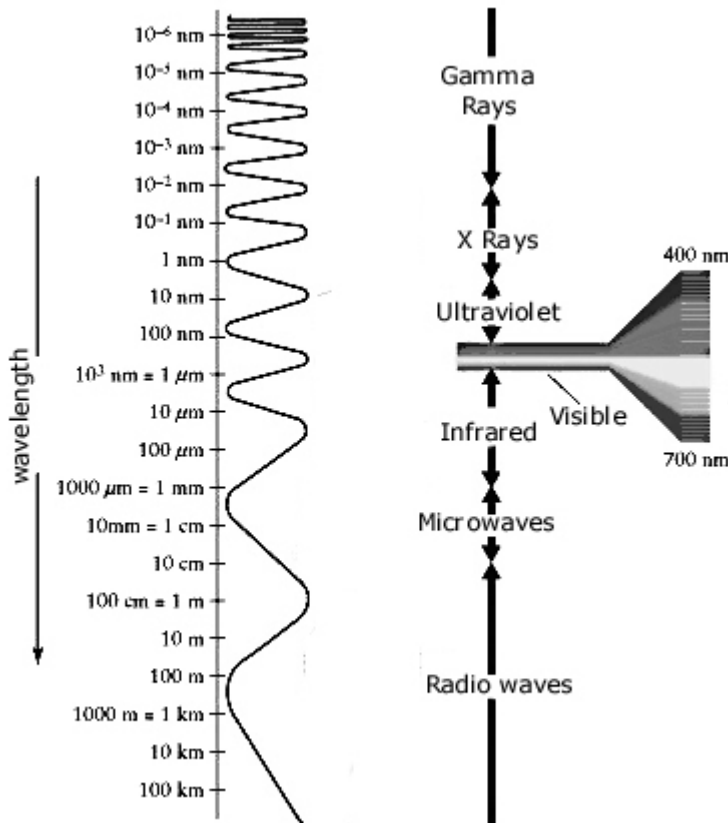

Visible Light wavelengths

Color of Light	Wavelength range (nm)
Violet	380-450
Blue	450-495
Green	495-570
Yellow	570-590
Orange	590-620
Red	620-750

- Which of the following wavelengths would be closest to visible red light?
  - 10-4.5nm
  - 650nm
  - 220cm
  - 700m
- A person affected by red-green color blindness would be unable to distinguish between which pair of light wavelengths?
  - 395 and 560 nm
  - 400 and 600 nm
  - 510 and 675 nm
  - 580 and 650 nm
- Microwave ovens heat food by exciting water molecules in the substance to be heated with microwaves, while conventional ovens heat a substance through infrared radiation which excites a wide variety of molecules. Which would then be true?
  - conventional ovens are more efficient at heating all substances.
  - conventional ovens are less efficient at heating all substances.
  - microwave ovens are more efficient at heating substances containing water, but are not necessarily useful for heating substances with little to no water.
  - substances containing water should not be heated in conventional ovens.
- Which of the following light wavelengths has the shortest range of wavelengths?
  - Red
  - Yellow
  - Green
  - Violet
- A light wave in a vacuum travels at the constant speed of just under 300 million meters per second, so as the wavelength of a light wave decreases, the frequency of the wave:
  - Increases
  - Decreases
  - Remains constant
  - Varies periodically

**PASSAGE III**

In evolutionary biology, the bottleneck effect is a term given to describe the change in genetic diversity of a population after an event which reduces the population by at least 50%. Due to only a fraction of the original population surviving, the frequency of certain genetic traits may be significantly different in the resulting population.

*Experiment 1*

In order to simulate the bottleneck effect, a student created a population of 1000 plastic pellets. 500 of them were blue representing the expression of trait A, while the remaining 500 were yellow representing the expression of trait B. The student then took independent samples of 500, 200, 100, and 25 from the original population, and then extrapolated the resulting percentages of yellow and blue pellets to 1000, simulating the continued growth and reproduction of the populations. The results are found in table 1

Population sample	yellow	blue	% yellow	% blue
1000	500	500	50	50
500	518	482	51.8	48.2
200	475	525	47.5	52.5
100	470	530	47.0	53.0
25	640	360	64.0	36.0

*Experiment 2*

A student took a population of 1000 fruit flies of which approximately 5% exhibited a recessive gene disorder which caused albinism (the total lack of color pigments). The parent population was randomly divided into fifty subgroups, each containing twenty flies. These subgroups were allowed to breed naturally until their populations reached 300 individuals. Then the prevalence of the albino (white) flies was calculated for each group, and the frequencies were tallied, as seen in table 2.

Percent albino flies	Number of colonies in range
0%	16
0.1-5%	21
5-10%	10
10-15%	2
15+%	1

12. What percentage of the colonies in experiment 2 experienced an increase in prevalence of the albino flies?
- F. 10%  
G. 16%  
H. 20%  
J. 26%
13. How many yellow pellets were found in experiment 1's sample of 500?
- A. 259  
B. 518  
C. 598  
D. 1026
14. Why must a population be reduced by over 50% in order to be affected by the bottleneck effect?
- F. A reduction of less than 50% would not affect the surrounding environment.  
G. A reduction of less than 50% would be less likely to change gene frequencies.  
H. The population would recover its original strength too soon after a reduction of less than 50%.  
J. Statistical significance mandates the use of at least 50% in this situation.
15. How many blue pellets would have been found in experiment 1's sample of 100?
- A. 47  
B. 53  
C. 92  
D. 530
16. Which of the following would be a good example of the bottleneck effect as described above?
- F. Several stowaway rats colonizing an island.  
G. Planting only corn in a field that had been mixed prairie grasses.  
H. A volcanic eruption destroying all but a few acres of a large forest.  
J. An avalanche burying the side of a mountain.
17. The bottleneck effect is a part of evolutionary biology because it:
- A. Forces individuals of a population to change their habits.  
B. Changes the frequency of genes in a population.  
C. Causes a change in the actual genes of some individuals.  
D. Allows for different behaviors in the population due to a decrease in individuals.



## PASSAGE IV

Many scientists attribute the phenomenon of global warming to the production of greenhouse gases which raise the earth's temperature by trapping heat inside the earth's atmosphere. However, some scientists disagree about which gases are the biggest threats to global warming and how these gases are entering the atmosphere.

*Scientist 1*

Carbon Dioxide ( $\text{CO}_2$ ) is a greater danger because there are massive amounts of  $\text{CO}_2$  that are in the atmosphere already and continue to be released into the atmosphere on a regular basis. There is over 220 times more  $\text{CO}_2$  than methane currently in the atmosphere.  $\text{CO}_2$  is the fourth greatest component of the atmosphere by volume at a concentration of 383 ppm (parts per million) and is one of the most efficient greenhouse gases at trapping incoming solar radiation in the form of heat.  $\text{CO}_2$  is released by burning organic matter, respiration of living organisms, and volcanic eruptions. Therefore, in order to slow global warming, more effort should be put into the removal of carbon dioxide from the atmosphere, a process called carbon sequestration. This should be accomplished by encouraging natural  $\text{CO}_2$  sinks like forests and by developing efficient artificial means in addition to using those artificial means already available.

*Scientist 2*

Methane ( $\text{CH}_4$ ) is more of a danger to the environment because of its global warming potential. In one hundred years, one kilogram of  $\text{CH}_4$  will warm the atmosphere some 20 times more than a kilogram of  $\text{CO}_2$ . At 1.745 ppm, Methane is the seventh greatest component of earth's atmosphere by volume. The majority of methane entering the atmosphere comes from human origins including rice and cattle farms, landfills, and energy production. While a large amount of methane is eventually removed from the atmosphere naturally by everyday chemical reactions, intentional removal of methane from the atmosphere by humans is difficult. Therefore, the most important way to reduce methane related global warming is to attempt to reduce emissions. The development of ways to artificially remove methane from the atmosphere or to enhance naturally occurring methane removal processes would also be beneficial for long term global temperature control.

18. Which of the following is NOT a significant contributor to atmospheric carbon dioxide?
- F. Forest fires
  - G. Slash and burn agriculture
  - H. Volcanic eruptions
  - J. Earthquakes
19. The majority of methane in the atmosphere:
- A. naturally occurs in the environment.
  - B. is associated with carbon sequestration.
  - C. combusts with carbon dioxide.
  - D. is difficult to remove by artificial means.
20. Legislation prohibiting the destruction of tropical rain forests would be in line with which scientist's viewpoint?
- F. Scientist 1, because it would limit release of  $\text{CO}_2$  as well as encourage carbon sequestration.
  - G. Scientist 1, because it would prohibit  $\text{CO}_2$  from being released by the ground.
  - H. Scientist 2, because it would prevent wood decay and release of methane.
  - J. Scientist 2, because the exposed soil would have absorbed excess methane.
21. Which of the following points would the scientists most likely agree upon?
- A. The need for a decrease in logging to stem gas emissions.
  - B. The need for continued advances in artificial greenhouse gas sequestration technologies.
  - C. The need for a decrease of human reliance on traditional agriculture.
  - D. The need for an increase in understanding of methane production.
22. If it were determined that the amount of methane in the atmosphere had decreased over the last ten years, it most likely would indicate that:
- F. The increasing amount of  $\text{CO}_2$  in the atmosphere is pushing down the levels of methane.
  - G.  $\text{CO}_2$  poses a greater threat to the stability of the environment.
  - H. The use of artificial sequestration techniques has decreased the previous levels of methane.
  - J. Efforts to reduce methane emissions have been successful in reducing the overall levels.





## PASSAGE V

Each element of the periodic table has unique characteristics. Students were given the following three tables with information on the metals Iron, Copper, Aluminum, Lead and Zinc to assist them on a chemistry assignment. Table 1 shows the atomic numbers and densities, Table 2 shows the specific heat (amount of heat needed to raise one cubic centimeter of a substance by one degree C) and latent heat of fusion (amount of heat absorbed by one gram of a substance as it changes from a liquid to a solid without increasing in temperature), and Table 3 gives the melting point (transition from solid to liquid) and boiling point (transition from liquid to gas).

Metal	Atomic Number	Density g/cm <sup>3</sup>
Aluminum	13	2.7
Iron	26	7.87
Copper	29	8.96
Zinc	30	7.14
Lead	82	11.3

Metal	Specific Heat (J/kg C)	Latent Heat of Fusion (J/kg)
Aluminum	$8.99 \times 10^2$	$3.96 \times 10^5$
Iron	$4.48 \times 10^2$	$2.67 \times 10^5$
Copper	$3.85 \times 10^2$	$2.05 \times 10^5$
Zinc	$3.90 \times 10^2$	$1.1 \times 10^5$
Lead	$1.28 \times 10^2$	$0.23 \times 10^5$

Metal	Melting Point (C°)	Boiling Point (C°)
Aluminum	660	2467
Iron	1535	2800
Copper	1083	2567
Zinc	418	907
Lead	327	1745

23. Based on the data in Tables 1 and 3, as boiling point decreases, density:
- Mostly increases
  - Mostly decreases
  - Remains constant
  - Changes sporadically with no trend
24. Based on the data in Tables 1 and 2, as atomic number increases, specific heat:
- increases only
  - decreases only
  - tends to increase
  - tends to decrease
25. If you were given an unknown metal X with a melting point of 1492 degrees C and a specific heat of  $4.50 \times 10^2$  J/kg C, X's boiling point would be closest to?
- 212 degrees C
  - 938 degrees C
  - 1501 degrees C
  - 2784 degrees C
26. If an alloy were made of Zinc and Lead, and if it were composed of equal volumes of each metal, what would the resulting alloy's density most logically be?
- $7.54 \text{ g/cm}^3$
  - $9.22 \text{ g/cm}^3$
  - $13.73 \text{ g/cm}^3$
  - $18.44 \text{ g/cm}^3$
27. As atomic number increases,
- Specific heat tends to increase
  - Specific heat tends to decrease
  - Specific heat tends to stay the same
  - Specific heat does not exhibit an apparent trend

## Passage VI

A capacitor is a device that stores electromagnetic energy in the form of potential energy. The measure of how much energy a capacitor can store is called the capacitance, which can be determined merely from knowing the geometry of a given capacitor (that is, its shape, the distance between its plates, etc.)

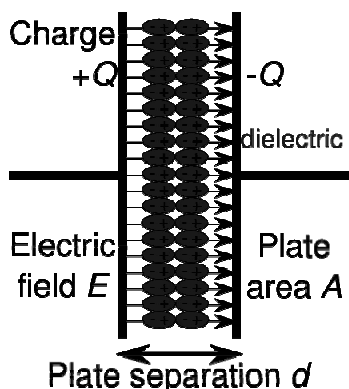

Three common types of capacitor geometries consist of two parallel plates, two coaxial cylinders, and two concentric spherical shells. Another common practice with capacitors is the insertion of a dielectric, a material that separates the plates of the capacitor. In the experiments below, scientists set up a potential difference of 9 volts between the plates of different parallel-plate capacitors and measure the capacitance in each use. The results are shown in Table 1.

Table 1

Distance between plates (mm)	Area of plates (m <sup>2</sup> )	Capacitance (pF)	Dielectric material	Dielectric constant of material
5	0.5	3.11	Paper	3.2
10	0.5	1.57	Paper	3.2
15	0.5	1.02	Paper	3.2
15	1.0	2.17	Paper	3.2
15	2.0	4.13	Paper	3.2
10	0.5	3.09	Ceramic	6.4
10	1.0	6.17	Ceramic	6.4
20	2.0	6.18	Ceramic	6.4
15	0.5	3.50	Glass	11
20	1.0	5.40	Glass	11
30	1.0	3.52	Glass	11

28. What is the capacitance (pF) of the plates when the distance between the plates is 15 and the area of the plates is 1.0 m<sup>2</sup>?

- F. 3.11
- G. 1.57
- H. 1.02
- J. 2.17

29. According to Table 1, doubling the distance between the plates:

- A. doubles the area of the plates.
- B. halves the area of the plates.
- C. has no effect on the dielectric constant of material.
- D. doubles the capacitance.

30. The dielectric constant of silicon is approximately the same as that of ceramic. A parallel plate capacitor with a silicon dielectric with a distance of 20 millimeters between the plates with area 2 square meters would have a capacitance of approximately:

- F. 3 pF.
- G. 6 pF.
- H. 11 pF.
- J. 19 pF.

31. One of the essential traits of a capacitor is that the plates do not touch. Thus, one benefit of adding a dielectric to a capacitor is that:

- A. the dielectric increases the electric field strength within the capacitor.
- B. the dielectric decreases the electric field strength within the capacitor.
- C. the dielectric provides a practical means of separating the plates.
- D. the dielectric makes the capacitor a better conductor of electricity.

32. According to the data in Table 1, doubling both the area of the plates and the distance between the plates:

- F. quadruples the capacitance.
- G. halves the capacitance.
- H. has no effect on the capacitance.
- J. doubles the capacitance.

33. According to the data in Table 1, the capacitance of a parallel plate capacitor with a paper dielectric and a separation of 15 millimeters between plates of area 1.5 square meters would most nearly be:

- A. 1 pF.
- B. 3 pF.
- C. 5 pF.
- D. 9 pF.

4



4

34. What materials had the highest dielectric constant?
- A. Paper and Ceramic
  - B. Glass and Paper
  - C. Ceramic and Glass
  - D. Paper only



Passage VII

Phylogenies are types of “family tree” diagrams that depict evolutionary relationships between species. They show how closely different species are related and give an indication of how different species developed from common ancestors. The groupings in the phylogenetic tree also follow the instinctive behavioral patterns of the insects that are observed in the field, as these are often specific to related groups of insects. The labels on the far right side of the figure indicate some of these behavioral relationships. The following phylogeny represents the relationships between cicadas (family: Cicadidae) of the genus *Kikihia*, which is native to New Zealand. The four species indicated by the asterisks (\*) are newly identified species, and their placement indicates the locations where a certain scientist feels they should be added to an existing phylogeny.

Figure 1

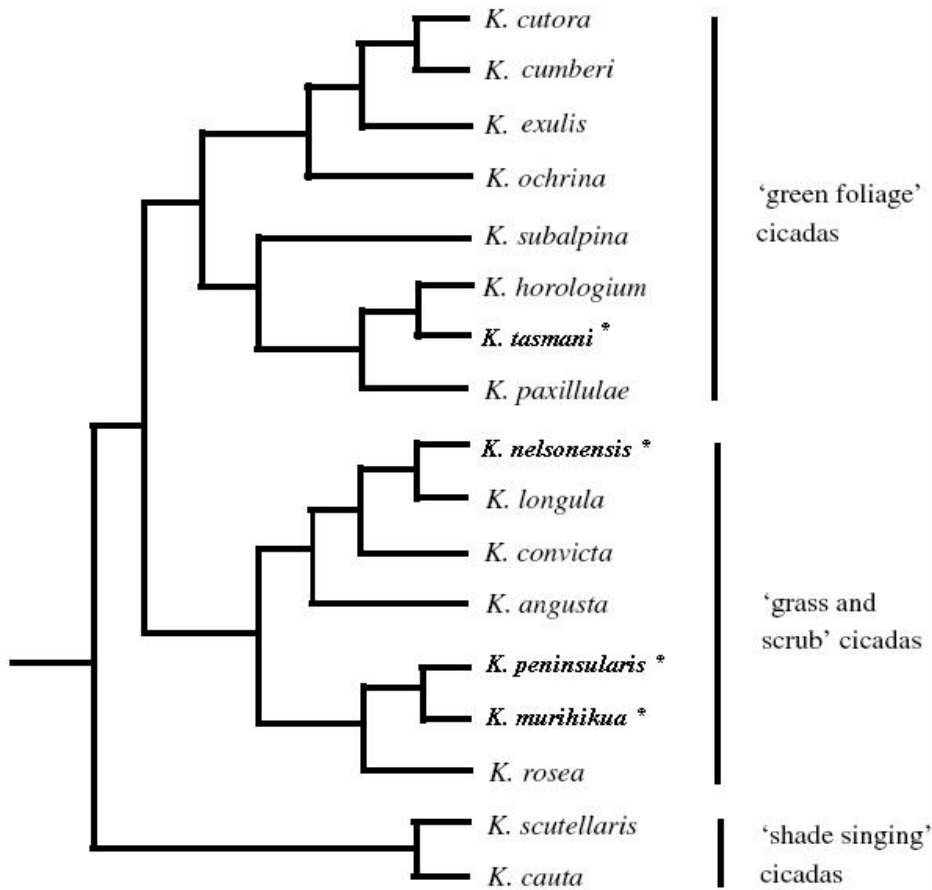



35. Which of the following pairs of cicada species is the LEAST closely related?

- A. *cutora* and *cumberi*
- B. *exulis* and *ochrina*
- C. *paxillulae* and *angusta*
- D. *rosea* and *scutellaris*

36. When comparing the relationships of individual species in a phylogenetic tree, the exact degree of relatedness is:

- F. Easy to determine by comparing the proximity of one species to that of another in the tree.
- G. Easy to determine by comparing how many levels back a pair of insects is related.
- H. Difficult to determine because the tree only shows relative relationships and the links are not quantifiable.
- J. Difficult to determine because all the species are in the same genus.

37. In the past, scientists had thought that the species *K. peninsularis* and *K. murihikua* were in fact one and the same. Which of the following recent discoveries regarding the group best indicates the existence of two separate species?

- A. The only physical difference between the two species is a slight variation in wing shape and color.
- B. The two proposed species cannot produce viable offspring when crossbred in the laboratory.
- C. The two proposed species occur on opposite sides of a mountain range.
- D. The two proposed species feed on different varieties of trees.

38. As noted in the phylogeny, many insect groups are identified by behavioral patterns. This complicates classification because:

- F. these behavioral patterns are often only observable in the field and may be difficult to replicate in laboratory situations.
- G. all insects seem to exhibit the same behaviors.
- H. insects reared in laboratories cannot learn these behaviors.
- J. it is not possible for scientists to comprehend the behaviors of insects in the laboratory.

39. If you were to observe a cicada singing its mating call while resting on a bunch grass in a field, you would most likely be observing which of the following species?

- A. *K. longula*
- B. *K. cauta*
- C. *K. cutora*
- D. *K. tasmani*

40. One species can diverge into two separate species through the process of diversifying selection, or when a selecting force favors two extremes of a population. Which of the following graphs best represents the idea of diversifying selection? (arrow indicates selection pressure)

F.

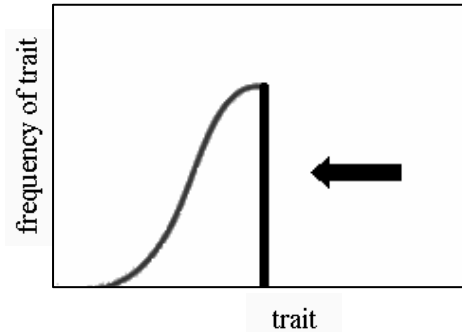

G.

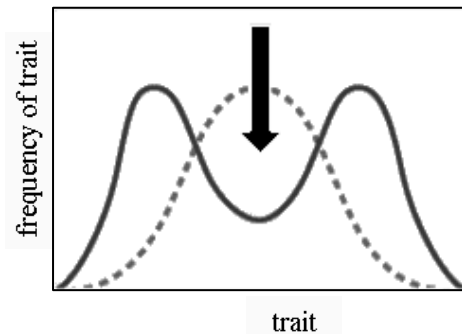

H.

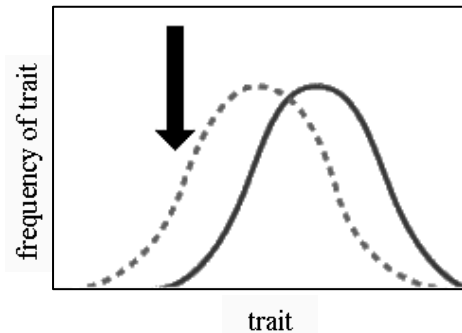

J.

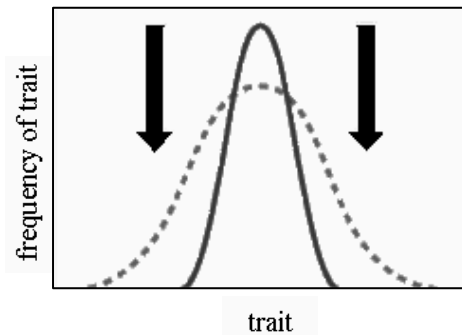

END OF TEST 4.

STOP! DO NOT RETURN TO  
ANY PREVIOUS TEST.

# JBTP Test #1

## Test 1: English—Scoring Key

<u>Key</u>	<u>Key</u>	<u>Key</u>	<u>Key</u>
1. C	21. C	41. A	61. A
2. G	22. G	42. J	62. J
3. D	23. D	43. A	63. D
4. F	24. J	44. F	64. H
5. B	25. A	<u>45. B</u>	65. B
6. G	26. G	46. H	66. J
7. C	27. C	47. B	67. D
8. F	28. G	48. F	68. G
9. C	29. B	49. D	69. B
10. J	<u>30. H</u>	50. G	70. J
11. C	31. B	51. C	71. B
12. J	32. H	52. F	72. J
13. A	33. D	53. D	73. B
14. F	34. J	54. G	74. H
<u>15. B</u>	35. C	55. B	75. D
16. G	36. H	56. J	
17. B	37. C	57. B	
18. J	38. J	58. H	
19. C	39. C	59. A	
20. G	40. G	<u>60. J</u>	

## Test 2: Mathematics—Scoring Key

<u>Key</u>	<u>Key</u>	<u>Key</u>	<u>Key</u>
1. A	16. G	31. E	46. J
2. J	17. C	32. J	47. D
3. D	18. K	33. B	48. K
4. H	19. A	34. H	49. B
5. C	20. G	35. A	50. G
6. H	21. C	36. H	51. B
7. E	22. K	37. D	52. G
8. J	23. E	38. K	53. D
9. E	24. F	39. E	54. H
10. J	25. C	40. H	55. B
11. E	26. H	41. D	56. G
12. G	27. D	42. J	57. E
13. D	28. F	43. B	58. J
14. G	29. D	44. H	59. D
15. D	30. F	45. B	60. H

## Test 3: Reading—Scoring Key

<u>Key</u>	<u>Key</u>	<u>Key</u>	<u>Key</u>
1. C	11. C	21. D	31. B
2. F	12. H	22. G	32. F
3. D	13. D	23. A	33. C
4. H	14. J	24. J	34. J
5. C	15. A	25. C	35. C
6. J	16. J	26. G	36. J
7. A	17. C	27. C	37. A
8. H	18. H	28. J	38. H
9. A	19. A	29. B	39. A
10. H	20. F	30. J	40. J

## Test 4: Science—Scoring Key

<u>Key</u>	<u>Key</u>	<u>Key</u>	<u>Key</u>
1. B	<u>11. A</u>	21. B	31. C
2. F	12. J	<u>22. J</u>	32. H
3. A	13. A	23. D	33. B
4. H	14. G	24. J	<u>34. H</u>
5. C	15. B	25. D	35. D
<u>6. H</u>	16. H	26. G	36. H
7. B	<u>17. B</u>	<u>27. B</u>	37. B
8. H	18. J	28. J	38. F
9. C	19. D	29. C	39. A
10. G	20. F	30. G	40. G

Number Correct (Raw Score) for:	
English	_____ (75)
Mathematics	_____ (60)
Reading	_____ (40)
Science	_____ (40)

Practice ACT Exam	Scale Score (see next page)
English	_____
Mathematics	_____
Reading	_____
Science	_____
Total (sum of all four)	
Composite (Total/4)	



**Procedures and Conversation Table Used to Obtain Scale Scores from Raw Scores for JBTP Test #1**

Use the JBTP table below to convert your raw score to scale scores. For each test, locate and circle your raw score in the table below. Then, read across to an outside column to find the scale score that corresponds to that raw score. Enter your scale scores in the blanks on p.45. The highest possible scale score for each test is 36.

Next, compute the Composite score by averaging the four scale scores. To do this, add your four scores and divide by 4. If the resulting number ends in a fraction, round it off to the nearest whole number. (Round down any fraction less than one-half; round up any fraction that is one-half or more.) This is your composite score. The highest possible Composite score is 36. The national average composite score is between 20 and 21.

Scale Score	Raw Scores				Scale Score
	Test 1 English	Test 2 Mathematics	Test 3 Reading	Test 4 Science	
36	75	60	39-40	40	36
35	—	—	38	—	35
34	74	59	37	39	34
33	73	58	36	—	33
32	72	57	35	38	32
31	70-71	55-56	34	—	31
30	68-69	53-54	33	37	30
29	66-67	52	32	36	29
28	64-65	51	31	34-35	28
27	61-63	49-50	30	33	27
26	58-60	47-48	29	31-32	26
25	56-57	45-46	27-28	29-30	25
24	53-55	42-44	26	28	24
23	51-52	40-41	25	26-27	23
22	49-50	37-39	23-24	24-25	22
21	46-48	34-36	22	23	21
20	43-45	32-33	20-21	21-22	20
19	41-42	31	19	19-20	19
18	38-40	29-30	18	17-18	18
17	35-37	26-28	17	14-16	17
16	32-34	23-25	16	13	16
15	29-31	20-22	15	11-12	15
14	26-28	17-19	13-14	9-10	14
13	24-25	14-16	12	8	13
12	22-23	10-13	10-11	6-7	12
11	20-21	6-9	8-9	5	11
10	17-19	5	7	—	10
9	14-16	4	6	4	9
8	12-13	—	5	3	8
7	10-11	3	—	2	7
6	8-9	2	4	—	6
5	6-7	—	3	—	5
4	5	—	—	1	4
3	3-4	1	2	—	3
2	2	—	1	—	2
1	0-1	0	0	0	1

# JBTP Test #1

## Practice ACT Assessment Answer Sheet

---

---

### ENGLISH

- |                    |                    |                    |                    |                    |                    |
|--------------------|--------------------|--------------------|--------------------|--------------------|--------------------|
| 1 (A) (B) (C) (D)  | 14 (F) (G) (H) (J) | 27 (A) (B) (C) (D) | 40 (F) (G) (H) (J) | 53 (A) (B) (C) (D) | 66 (F) (G) (H) (J) |
| 2 (F) (G) (H) (J)  | 15 (A) (B) (C) (D) | 28 (F) (G) (H) (J) | 41 (A) (B) (C) (D) | 54 (F) (G) (H) (J) | 67 (A) (B) (C) (D) |
| 3 (A) (B) (C) (D)  | 16 (F) (G) (H) (J) | 29 (A) (B) (C) (D) | 42 (F) (G) (H) (J) | 55 (A) (B) (C) (D) | 68 (F) (G) (H) (J) |
| 4 (F) (G) (H) (J)  | 17 (A) (B) (C) (D) | 30 (F) (G) (H) (J) | 43 (A) (B) (C) (D) | 56 (F) (G) (H) (J) | 69 (A) (B) (C) (D) |
| 5 (A) (B) (C) (D)  | 18 (F) (G) (H) (J) | 31 (A) (B) (C) (D) | 44 (F) (G) (H) (J) | 57 (A) (B) (C) (D) | 70 (F) (G) (H) (J) |
| 6 (F) (G) (H) (J)  | 19 (A) (B) (C) (D) | 32 (F) (G) (H) (J) | 45 (A) (B) (C) (D) | 58 (F) (G) (H) (J) | 71 (A) (B) (C) (D) |
| 7 (A) (B) (C) (D)  | 20 (F) (G) (H) (J) | 33 (A) (B) (C) (D) | 46 (F) (G) (H) (J) | 59 (A) (B) (C) (D) | 72 (F) (G) (H) (J) |
| 8 (F) (G) (H) (J)  | 21 (A) (B) (C) (D) | 34 (F) (G) (H) (J) | 47 (A) (B) (C) (D) | 60 (F) (G) (H) (J) | 73 (A) (B) (C) (D) |
| 9 (A) (B) (C) (D)  | 22 (F) (G) (H) (J) | 35 (A) (B) (C) (D) | 48 (F) (G) (H) (J) | 61 (A) (B) (C) (D) | 74 (F) (G) (H) (J) |
| 10 (F) (G) (H) (J) | 23 (A) (B) (C) (D) | 36 (F) (G) (H) (J) | 49 (A) (B) (C) (D) | 62 (F) (G) (H) (J) | 75 (A) (B) (C) (D) |
| 11 (A) (B) (C) (D) | 24 (F) (G) (H) (J) | 37 (A) (B) (C) (D) | 50 (F) (G) (H) (J) | 63 (A) (B) (C) (D) |                    |
| 12 (F) (G) (H) (J) | 25 (A) (B) (C) (D) | 38 (F) (G) (H) (J) | 51 (A) (B) (C) (D) | 64 (F) (G) (H) (J) |                    |
| 13 (A) (B) (C) (D) | 26 (F) (G) (H) (J) | 39 (A) (B) (C) (D) | 52 (F) (G) (H) (J) | 65 (A) (B) (C) (D) |                    |

---

---

### MATHEMATICS

- |                        |                        |                        |                        |                        |                        |
|------------------------|------------------------|------------------------|------------------------|------------------------|------------------------|
| 1 (A) (B) (C) (D) (E)  | 11 (A) (B) (C) (D) (E) | 21 (A) (B) (C) (D) (E) | 31 (A) (B) (C) (D) (E) | 41 (A) (B) (C) (D) (E) | 51 (A) (B) (C) (D) (E) |
| 2 (F) (G) (H) (J) (K)  | 12 (F) (G) (H) (J) (K) | 22 (F) (G) (H) (J) (K) | 32 (F) (G) (H) (J) (K) | 42 (F) (G) (H) (J) (K) | 52 (F) (G) (H) (J) (K) |
| 3 (A) (B) (C) (D) (E)  | 13 (A) (B) (C) (D) (E) | 23 (A) (B) (C) (D) (E) | 33 (A) (B) (C) (D) (E) | 43 (A) (B) (C) (D) (E) | 53 (A) (B) (C) (D) (E) |
| 4 (F) (G) (H) (J) (K)  | 14 (F) (G) (H) (J) (K) | 24 (F) (G) (H) (J) (K) | 34 (F) (G) (H) (J) (K) | 44 (F) (G) (H) (J) (K) | 54 (F) (G) (H) (J) (K) |
| 5 (A) (B) (C) (D) (E)  | 15 (A) (B) (C) (D) (E) | 25 (A) (B) (C) (D) (E) | 35 (A) (B) (C) (D) (E) | 45 (A) (B) (C) (D) (E) | 55 (A) (B) (C) (D) (E) |
| 6 (F) (G) (H) (J) (K)  | 16 (F) (G) (H) (J) (K) | 26 (F) (G) (H) (J) (K) | 36 (F) (G) (H) (J) (K) | 46 (F) (G) (H) (J) (K) | 56 (F) (G) (H) (J) (K) |
| 7 (A) (B) (C) (D) (E)  | 17 (A) (B) (C) (D) (E) | 27 (A) (B) (C) (D) (E) | 37 (A) (B) (C) (D) (E) | 47 (A) (B) (C) (D) (E) | 57 (A) (B) (C) (D) (E) |
| 8 (F) (G) (H) (J) (K)  | 18 (F) (G) (H) (J) (K) | 28 (F) (G) (H) (J) (K) | 38 (F) (G) (H) (J) (K) | 48 (F) (G) (H) (J) (K) | 58 (F) (G) (H) (J) (K) |
| 9 (A) (B) (C) (D) (E)  | 19 (A) (B) (C) (D) (E) | 29 (A) (B) (C) (D) (E) | 39 (A) (B) (C) (D) (E) | 49 (A) (B) (C) (D) (E) | 59 (A) (B) (C) (D) (E) |
| 10 (F) (G) (H) (J) (K) | 20 (F) (G) (H) (J) (K) | 30 (F) (G) (H) (J) (K) | 40 (F) (G) (H) (J) (K) | 50 (F) (G) (H) (J) (K) | 60 (F) (G) (H) (J) (K) |

---

---

### READING

- |                   |                    |                    |                    |                    |                    |
|-------------------|--------------------|--------------------|--------------------|--------------------|--------------------|
| 1 (A) (B) (C) (D) | 8 (F) (G) (H) (J)  | 15 (A) (B) (C) (D) | 22 (F) (G) (H) (J) | 29 (A) (B) (C) (D) | 36 (F) (G) (H) (J) |
| 2 (F) (G) (H) (J) | 9 (A) (B) (C) (D)  | 16 (F) (G) (H) (J) | 23 (A) (B) (C) (D) | 30 (F) (G) (H) (J) | 37 (A) (B) (C) (D) |
| 3 (A) (B) (C) (D) | 10 (F) (G) (H) (J) | 17 (A) (B) (C) (D) | 24 (F) (G) (H) (J) | 31 (A) (B) (C) (D) | 38 (F) (G) (H) (J) |
| 4 (F) (G) (H) (J) | 11 (A) (B) (C) (D) | 18 (F) (G) (H) (J) | 25 (A) (B) (C) (D) | 32 (F) (G) (H) (J) | 39 (A) (B) (C) (D) |
| 5 (A) (B) (C) (D) | 12 (F) (G) (H) (J) | 19 (A) (B) (C) (D) | 26 (F) (G) (H) (J) | 33 (A) (B) (C) (D) | 40 (F) (G) (H) (J) |
| 6 (F) (G) (H) (J) | 13 (A) (B) (C) (D) | 20 (F) (G) (H) (J) | 27 (A) (B) (C) (D) | 34 (F) (G) (H) (J) |                    |
| 7 (A) (B) (C) (D) | 14 (F) (G) (H) (J) | 21 (A) (B) (C) (D) | 28 (F) (G) (H) (J) | 35 (A) (B) (C) (D) |                    |

---

---

### SCIENCE

- |                   |                    |                    |                    |                    |                    |
|-------------------|--------------------|--------------------|--------------------|--------------------|--------------------|
| 1 (A) (B) (C) (D) | 8 (F) (G) (H) (J)  | 15 (A) (B) (C) (D) | 22 (F) (G) (H) (J) | 29 (A) (B) (C) (D) | 36 (F) (G) (H) (J) |
| 2 (F) (G) (H) (J) | 9 (A) (B) (C) (D)  | 16 (F) (G) (H) (J) | 23 (A) (B) (C) (D) | 30 (F) (G) (H) (J) | 37 (A) (B) (C) (D) |
| 3 (A) (B) (C) (D) | 10 (F) (G) (H) (J) | 17 (A) (B) (C) (D) | 24 (F) (G) (H) (J) | 31 (A) (B) (C) (D) | 38 (F) (G) (H) (J) |
| 4 (F) (G) (H) (J) | 11 (A) (B) (C) (D) | 18 (F) (G) (H) (J) | 25 (A) (B) (C) (D) | 32 (F) (G) (H) (J) | 39 (A) (B) (C) (D) |
| 5 (A) (B) (C) (D) | 12 (F) (G) (H) (J) | 19 (A) (B) (C) (D) | 26 (F) (G) (H) (J) | 33 (A) (B) (C) (D) | 40 (F) (G) (H) (J) |
| 6 (F) (G) (H) (J) | 13 (A) (B) (C) (D) | 20 (F) (G) (H) (J) | 27 (A) (B) (C) (D) | 34 (F) (G) (H) (J) |                    |
| 7 (A) (B) (C) (D) | 14 (F) (G) (H) (J) | 21 (A) (B) (C) (D) | 28 (F) (G) (H) (J) | 35 (A) (B) (C) (D) |                    |